

50 Hz



Serie GVF11-GVF12-GVF13

VARIABLE-SPEED BOOSTER SETS WITH
VERTICAL MULTISTAGE ELECTRIC PUMPS e-SV™ SERIES

Cod. 191000521 Rev.C Ed.11/2017

 **LOWARA**
a xylem brand

CONTENTS

General introduction	4
Choice and selection	9
GVF.../SV Series	24
Range	26
Characteristics of the electric pumps	27
Hydraulic performance tables	34
Electric data tables	43
GVF11D - GVF11Y Series	46
GVF12D - GVF12Y Series	56
GVF13D - GVF13Y Series	66
Operating characteristics.....	75
Hc pressure drop curve	95
Accessories	99
Technical Appendix	105

BOOSTER SETS GVF SERIES

GENERAL INTRODUCTION - PRODUCT DESCRIPTION

GVF series booster sets are designed to transfer and increase the pressure of water, in the following applications:

- Hospitals
- Schools
- Public buildings
- Industries
- Hotels
- Condominiums
- Sports facilities
- Mains water systems

GVF series booster sets are pumping stations assembled with two up to a maximum of six vertical multistage pumps from the e-SV series.

The pumps are connected to one another by suction and delivery pipes, and fixed onto a single base.

The pumps are connected to the manifolds by means of stop valves and check valves.

An electric protection and control panel is installed using a bracket on the base of the set.

In the case of particularly large electric panels, they are installed on the floor.

GVF series booster sets offer different regulating possibilities and are divided into the following versions:

GVF series F

Pressure boosting sets with 2 to 6 e-SV series pumps and only one frequency converter inside the electric panel. Variable speed operation alternates between pumps in the booster set.

GVF series booster sets have been defined with a wide range of pumps to satisfy the different needs of every system. However, they can also offer the GVF series with customisation to satisfy particular working requirements.

Systems for regulating the speed of the electric motors, as in GVF series booster sets, are used in the following cases:

- In the case of systems with a lot of users where the daily consumption varies frequently and in different periods.
- When it is necessary to obtain constant pressure.
- In the case of systems with supervision it is possible to monitor and check the performances of the pump stations.

These systems improve comfort for the final user, reducing the noise emissions and, thanks to the gradual switching off of the pumps, they guarantee a significant reduction of water hammer in the system.

BOOSTER SETS GVF SERIES DESCRIPTION OF OPERATION

In GVF series booster sets only one electric pump operates at variable speed, while the others operate at fixed speed.

The pump is driven by a frequency converter directly inside the electric panel; the other pumps, up to a maximum of five, are started by contactors.

All the pumps are controlled by the SD60 control unit which is on the front of the electric panel door.

The pump driven by the inverter modulates its speed according to the system demand, while the other pumps run at maximum speed.

The first pump to start will always be the one connected to the frequency converter, the other pumps will start in sequence after the first. It is possible to have automatic alternation of the fixed-speed pumps to distribute wear and allow the pumps to operate for a uniform number of hours.

Starting and stopping of the pumps is determined according to the set value of pressure in the control board menu. The pressure value is read by a pressure transducer connected to the SD60 control unit.

Example operation of a set of three GVF series pumps, version F.

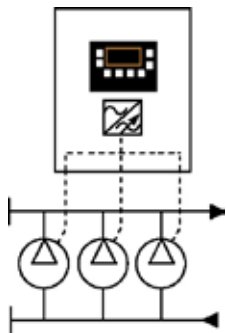

Only example for GVF120...

Only one pump is controlled by the converter inside the electric panel. At each new starting cycle of the pumps, the frequency converter moves on to the next pump, ensuring speed adjustment is alternated for all the pumps installed.

When the demand for water decreases, the pumps will stop in cascade and the last one to stop will be the one connected to the frequency converter.

The pump connected to the frequency converter keeps the pressure constant by modulating the number of motor revs.

GVF series booster sets guarantee constant pressure of the system as in the following example:

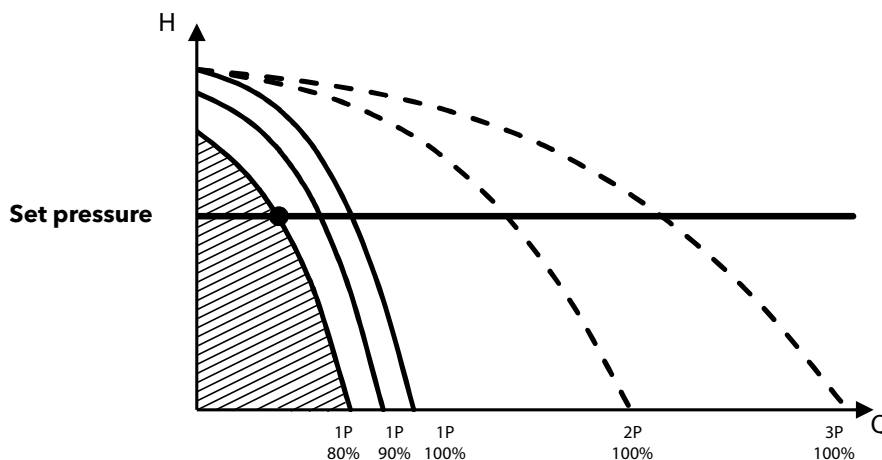

BOOSTER SETS GVF SERIES DESCRIPTION OF OPERATION

When there is a demand for water, the pump controlled by the converter will start, positioning its speed to guarantee the set pressure value. When the demand for water increases, the other pumps will start operating at maximum speed, while the first pump connected to the converter will start to modulate its speed to maintain constant pressure.

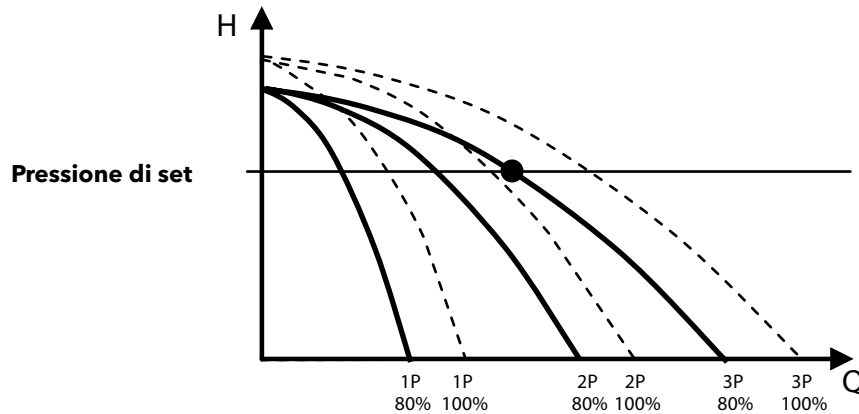

When the demand for water decreases, the pumps switch off in cascade, depending on the pressure value. The first pump (running at variable speed) decreases the number of revs to a set minimum before switching off.

Regulating the constant pressure value

GVF series booster sets guarantee constant pressure of the system even during frequent variations in water consumption.

When the booster set is connected to the system, the pressure value is read through the transducer fitted on the delivery of the system. The value found is compared with the set value. The check between the pressure value found and the set value is made by means of the PID regulator, which corrects the difference between the two values, acting on the frequency variation/number of motor revs, modifying the pump performance over time. The PID regulator is in the SD60 control board.

In the event of breakdown of the frequency converter, the SD60 board automatically takes control of the booster set functions.

Type of control

GVF series booster sets use a sensor as a standard device to control pressure. For each booster set there are two transducers (one standby) where, in the event of breakdown of the first, control automatically passes to the second.

The SD60 control board allows the use of other control devices such as flow, temperature or level transducers, according to the needs of the system. It is possible to set the measuring unit directly from the control board menu. These control devices must be specifically requested, as they are not used as standard features on GVF series pressure booster sets.

Setpoint

With the SD60 it is possible to set up to six setpoints with different values, as well as the original setpoint. In this way the booster set can be used for systems with a large extension and different levels.

For example, different setpoints can be used for an irrigation system on a hillside, or one setpoint value can be used for domestic water supply during the day and a second setpoint for irrigation at night.

The setpoints may be changed by means of a timetable, set via the clock inside the SD60 control board or with an external consent (external device).

BOOSTER SETS GVF SERIES DESCRIPTION OF OPERATION

Timing the starting and stopping of the pumps

This function allows the improvement of the reaction time on starting or stopping of the pumps, in order to satisfy the demand of the system while optimising the number of stops and starts per hour.

Each time a pump starts or stops, if the correct delay time for that type of system has been set, the pump will stop or start only after a certain period of time. This allows the pump to remain operating without having to stop at the set pressure value. This prevents the pump restarting suddenly immediately after stopping due to a sudden lowering of the pressure due to the demand for water.

A good adjustment of the pump starting and stopping times will avoid an excessive number of starts per hour.

Standby pump

It is possible to use a standby pump on GVF series booster sets, which will start up only if there is a breakdown in one of the pumps in the set. The standby pump will become like a regular pump, controlled in the same way as the others. If the cyclical exchange of pumps is activated, the standby pump will operate automatically. The performance of the booster set is guaranteed with the standby pump, even if one of its pumps is out of service.

Cyclical exchange of pumps

If this function is activated, working hours will be equally shared among the installed pumps. At each restart the pumps are exchanged, even using those which are never activated because water demand is lower than the booster set performance.

It is also possible to force a cyclical exchange if the pumps have been running for long periods without stopping. The time at which the pumps will be exchanged can be set directly from the menu of the SD60 control board, rather than automatically.

Automatic auto-test

In GVF series booster sets it is possible to activate the automatic auto-test function; this function is used when the pumps do not operate frequently.

The main purpose of the automatic auto-test is to start the pumps to avoid blocking of the mechanical seal due to impurities left by the pumped liquid, and to eliminate any air pockets left trapped in the pump.

The automatic auto-test can be activated from the menu of the SD60 control board and its day and duration are set using the clock.

It is possible to order GVF series booster sets with the auto-test already set; in this case a water discharge circuit will be provided on the delivery manifold.

It is important to remember that a discharge circuit with a solenoid valve must be provided to avoid overheating the water inside the pump body during the auto-test.

Protection against dry running

The protection function against dry running intervenes if the water reserve to which the booster set is connected falls below the minimum level guaranteed for suction.

For GVF series booster sets the level may be controlled by a float, level probes or minimum pressure switch.

It is also possible to manage the function directly by inputting a minimum pressure value in the SD60 control board menu, which will receive a signal from the pressure transducer.

BOOSTER SETS GVF SERIES ENERGY SAVING

The worldwide demand for energy is growing all the time and, while the demand is increasing, production is coming up against serious problems of an environmental nature and related to the supply of raw materials. In other words, energy is an asset that is becoming more precious every day, imposing choices to optimise consumption, especially with a view to safeguarding the environment.

A very important improvement role is played by new technologies which include, among the most desirable parameters, environmental protection and energy saving as well as best technical performance. Drives for electric motors fall into this category. As well as making a considerable contribution to the decrease in energy consumption and consequently to the improvement of the environment, in many applications they also produce a notable reduction in the overall costs of running the installations.

Drives for Electric Motors

The electronic drives that are most involved in the general improvement of the quality of systems and installations, are those for asynchronous alternating current motors, generally three-phase induction motors. They may be divided into two large categories:

- Drives with variable voltage
- Drives with variable frequency

The first, called "starters" or "soft starters", are appliances that operate at constant frequency (that of the power mains), dose the voltage supplied to the load and have limited current. The operation it's visible in the picture 1

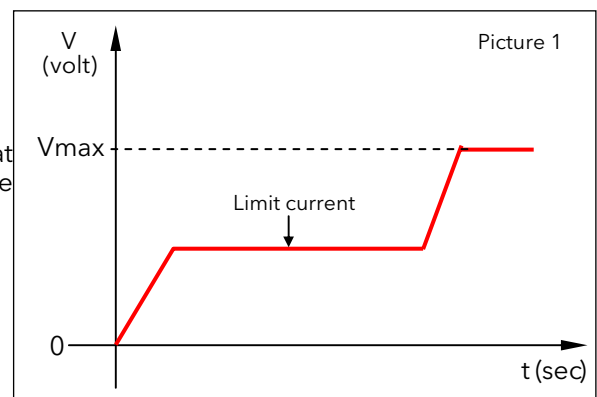

The second, called "Inverters" or "frequency converters" are most important from the point of view of energy saving and are able to supply the motor with a practically sinusoidal current (PMW) at a frequency that may vary from a value of practically 0 Hz to a rated frequency and beyond, with a constant flow (torque) or constant power. The operation it's visible in the picture 2

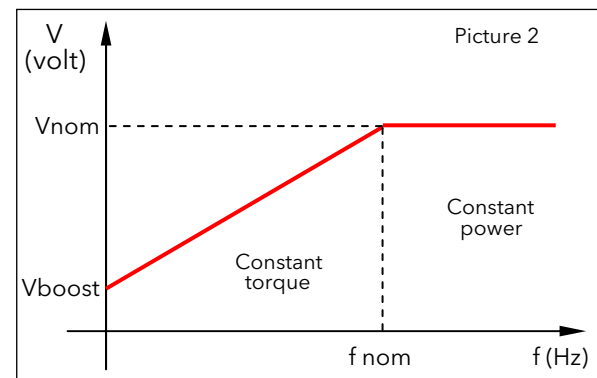

Softstart

The direct starting of an asynchronous motor presents considerable difficulties due to the peak current in the start phase. Typically the value of the starting current is about 7/8 times the rated current of the motor. Direct start systems are therefore not generally convenient (except for small power); mainly because of the need to increase the size of the power supply mains (switches, fuses, etc. ...), and also problems of a mechanical nature, due to high stress in the start phase which in the medium/long term may prove to be destructive.

The electrical engineering industry has already found various practical solutions to the problems; the main ones are noted below:

- Special motors with double winding
- Starting with autotransformer
- Star/delta starting

These starting systems are certainly an improvement on direct starting, but they do not solve the problem. The advent of electronic starters ("soft starters") made a decisive contribution to solving the question.

BOOSTER SETS GVF SERIES CHOICE AND SELECTION

The following conditions should be considered when choosing a booster set:

- The system's requirements should be met regarding flow rate and pressure.
- The booster set must not be oversized, avoiding unnecessary installation and running costs.

Generally water distribution systems such as those for domestic water supply or for large agglomerates such as hospitals, hotels or similar, have "variable" water consumption i.e. in a 24-hour period there may be sudden variations in consumption that are difficult to foresee.

A pattern of consumption may occur in 24 hours, but the daily percentage of booster set operation may also occur at various flow rates.

Generally the definition of flow rate for these types of systems is based on either the "probability calculation" which is a very complex system of calculation, or based on tables or diagrams in the national standards which provide guidelines for the sizing of the systems and therefore for calculating the maximum simultaneous flow rate.



The operating time of the booster set, still calculated over 24h, gives us a view of the daily percentage of operation at the various flow rates.

This means that there may be daily peaks where the maximum flow rate requested is concentrated in a short space of time. In the example given below, it can be seen that in 100% of the time there is a consumption of 4 m m³/h, while in 20% of the operating time there is a consumption of 40 m³/h.

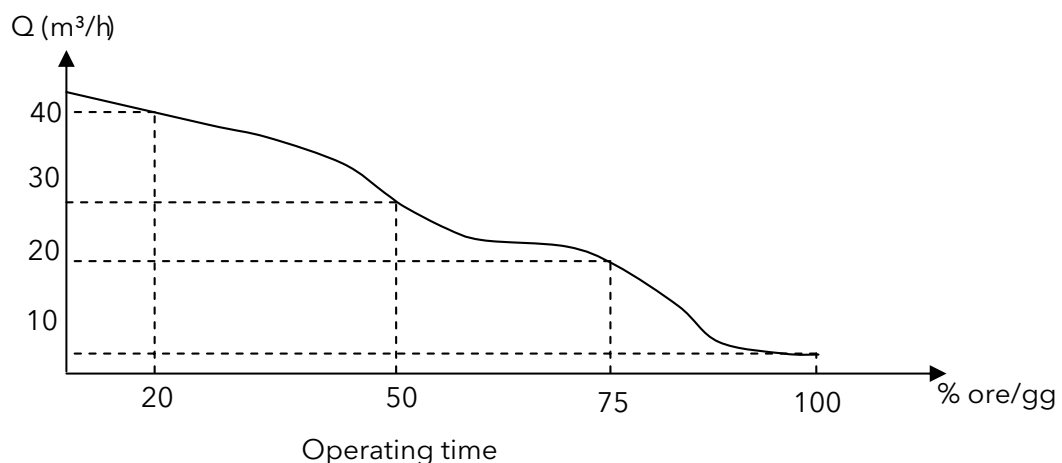

BOOSTER SETS GVF SERIES CHOICE AND SELECTION

When selecting the booster set the consumption figure of the system must be considered, which is generally supplied by the person who designed the system.

For systems where consumption varies continuously and suddenly over time it is advisable to install GVF series booster sets with variable regulation of the pump speed.

The calculation of the size of the booster set (its performance and the number of pumps) is based on the take-off point and therefore on the consumption value which takes the following factors into account:

- The value of the peak in consumption
- Efficiency
- NPSH
- Standby pumps
- Jockey pumps
- Diaphragm tanks

By adjusting their operation over time, variable-speed booster sets give the end user energy savings which can be calculated directly on the control board with a metering module fitted in the electric panel.

This allows checking of the system efficiency, especially in complex systems with many users and many ranges of consumption.

It is possible to install a standby pump if it is necessary to have some kind of additional safety in the pump station. This is typical in systems of a certain importance, such as hospitals or factories, or in the field of crop irrigation. If small users have to be served in the same system, it is preferable to install what is commonly called a jockey pump, where instead of running the main pump, which usually has higher power, the service is guaranteed with a smaller pump and therefore lower energy consumption.

GVF series booster sets must also be equipped with diaphragm tanks (for the size of the tank, see the specific chapter in this catalogue).

A single tank can be installed on the delivery side of the booster set, or smaller tanks, maintaining the same total volume.

Diaphragm tanks avoid the risk of water hammer, which is harmful for both the system and the pumps.

Generally for systems with highly variable or sudden variations in consumption, it is recommended to install a booster set with variable pump speed, such as the GVF series, to guarantee constant pressure.

BOOSTER SETS GVF SERIES INSTALLATION

GVF series booster sets must be installed in areas protected against frost and with adequate ventilation to cool the motors. It is good practice to connect the suction and delivery pipes with vibration-damping joints to limit vibrations and resonance in the whole system.

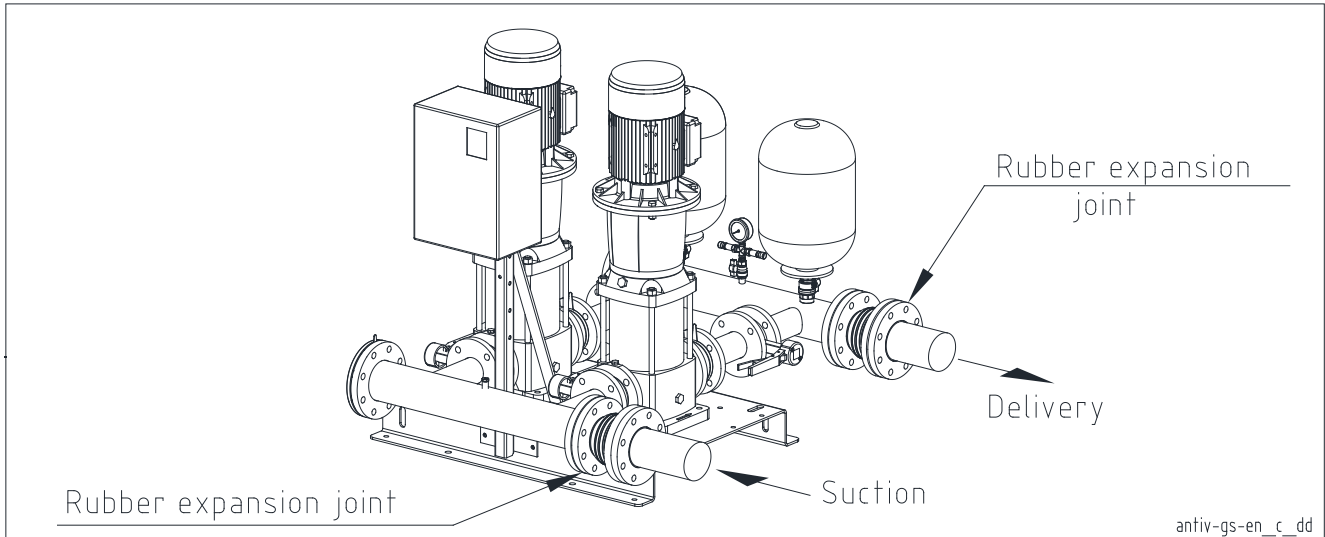

GVF series booster sets must be connected to pressurised tanks with an adequate capacity for the system. These tanks can avoid any problems due to water hammer that is created due to the sudden stopping of the pumps running at a fixed speed. For this type of system, 24-litre diaphragm tanks can be used that perform a pressure dampening function, since they do not have to provide water storage like ordinary autoclave systems. Due to their design, variable-speed booster sets can satisfy users' demands by moderating the pump speed. It is always recommended to check the type of system to be made and choose the correct capacity of the diaphragm tank accordingly.

For the sizing of the diaphragm tanks, see the specific chapter in this catalogue.

Considering also that variable-pressure sets are very sensitive to swings of pressure in the system, the use of diaphragm tanks allows the pressure to stabilise when requests are low or inexistent, and avoids the pumps remaining in operation at minimum speed without stopping.

It is good practice to check the value of the maximum pump pressure to match the set with a tank suitable for the pressure value.

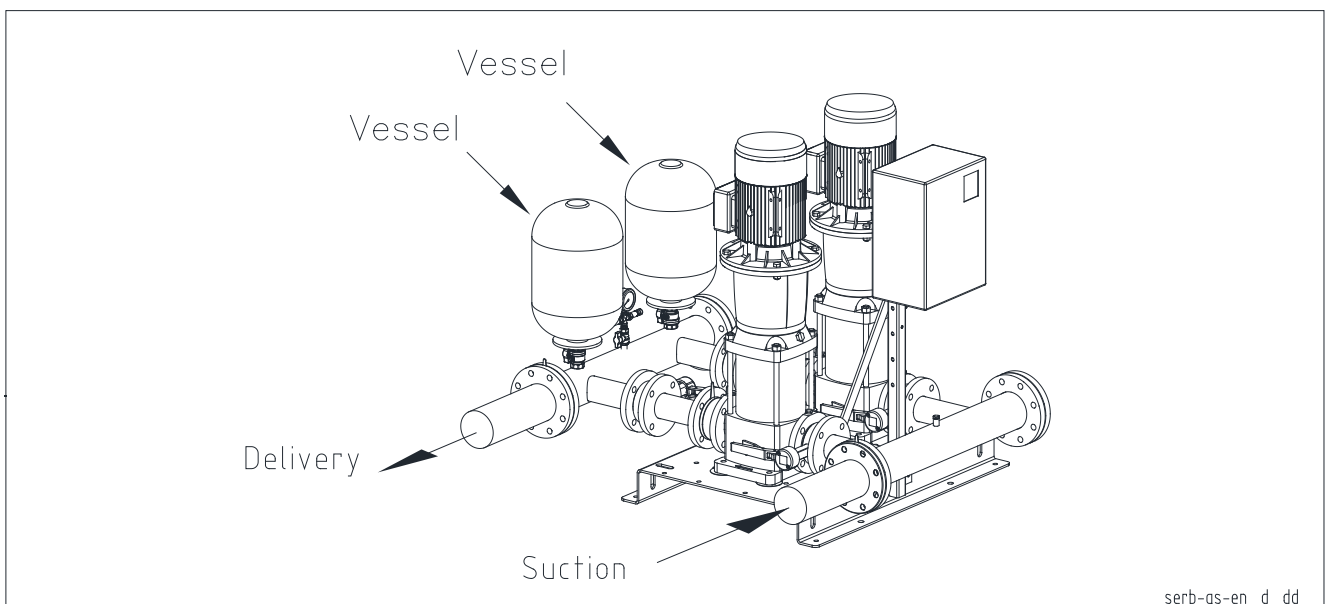

GVF BOOSTER SETS SERIES SELECTING THE PUMPS

What type of pump to choose?

Generally, the selection of pump is based on the maximum duty point of the system, which is usually the highest possible. The maximum request value is normally for short periods, so the pump must also be able to satisfy variable requests throughout its time in service.

Generally the choice of the pump, based on the performance curve, should fall around the maximum efficiency point. The pump must ensure operation within its rated performance.

Since the unit is sized according to the maximum possible consumption, the maximum duty point of the pumps must be in the area on the right of the performance curve so that, if there is a fall in consumption, the efficiency remains high.

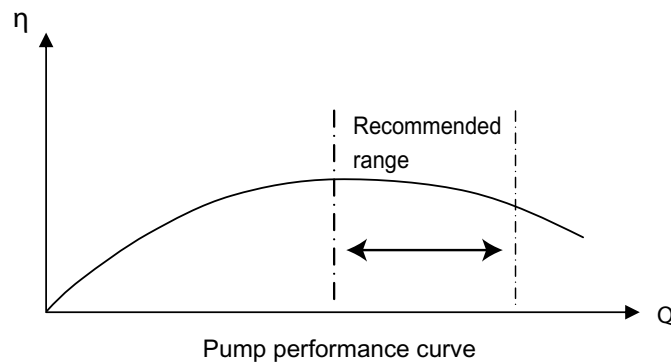

If we make a choice on the characteristic curve of the pump, we can see that the area where it is best to select the pump is represented by the following graph:

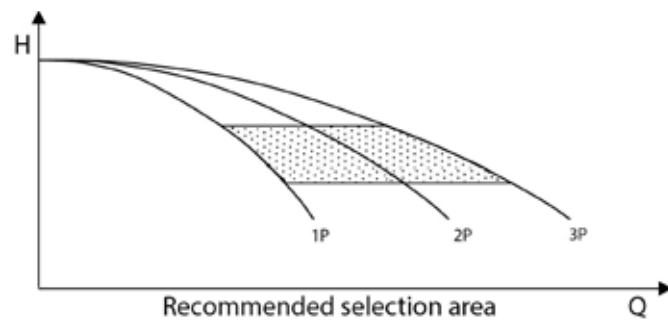

Another factor to be considered when choosing the pumps is its NPSH value. Never choose a pump where the maximum duty point is too far to the right of the NPSH curve.

This risks not having good pump suction, which may be aggravated by the type of installation (where negative suction is possible).

In these cases there is the risk of cavitation.

The NPSH of the pump must always be checked at the maximum flow rate requested.

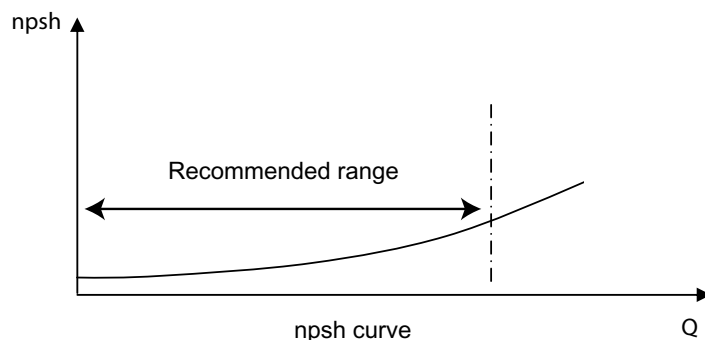

BOOSTER SETS GVF SERIES ENERGY SAVING

This type of drive is able to supply performance advantages:

- Progressive start with a voltage ramp having a duration adjustable within wide time limits.
- Limited current start with a value that can be set from 100% to 500% of the rated value.
- Descending voltage ramp having a duration adjustable within wide time limits.
- Voltage ramps at starting and stopping adaptable to particular operations (pumps).
- Low-speed operation, with reversible running direction, for specific applications.
- "Energy Saving" function with automatic reduction of the voltage/current in the case of a prolonged underload.
- Safety devices that can be calibrated to prevent overheating of the motor, over/under currents and over/under voltages.
- Safety devices that can be calibrated to prevent prolonged or too frequent starts.
- Possibility of by-pass operation after starting, keeping all the safety devices active.

All these features make the electronic starter the ideal tool for solving the problems we have mentioned. With the recently designed starters, with both analog and digital control, it is possible to obtain considerable softer and more efficient starts than any other electromechanical system was able to achieve. Moreover, thanks to the intrinsic control and protection systems of the starter, it is generally possible to eliminate other protection equipment that would otherwise be necessary in the system.

In conclusion, in many applications, one can SAVE on:

- Structure and auxiliary equipment of the power supply system.
- Protection of the mechanical system against excessive stress.

Speed Adjustment

The speed adjustment systems allow energy consumption in proportion to the use of the system based on user demand. This allows considerable savings in systems working on a daily basis (24h).

Alongside applications that require operation of the electric motors at a constant speed, with steady voltage and frequency, there are many in which the electric motor must be able to vary its speed of rotation (frequency); moreover, in many applications the process control obtained by varying the speed (adjustment of flow rate, pressure, etc...) is much more convenient than any other method of adjustment.

For these applications the most suitable drives are certainly frequency converters, referred to below as "Inverters", which can supply the motor with the desired torque from a few rpm up to the rated speed beyond which they are still able to operate at constant power with a decreasing torque. The advantage of using the Inverter lies in the greater efficiency of the performance that it is able to give in comparison with electromechanical controls. A useful application of frequency converters may simply be that of obtaining a soft start for a load that is particularly heavy to start (pump) and variable over time (flow rate). In any case the advantage of a soft start is present in all inverter-controlled systems for starting a motor, even in cases where speed adjustment is not needed.

The advantage is due to the fact that the inverter is able to supply the rated torque (with possibility of 150% overload with respect to the rated current), right from frequency zero. This is possible because the voltage to the motor, generated by the inverter, is in phase with the number of revolutions right from the start (unless the motor is running). In this way the losses in the motor are considerably reduced.

The starting torque that can be obtained using the inverter is greater than that obtained with a soft starter, and the demand for current in the whole starting phase is much lower.

The yearly saving, for a lost power of 40000 kWh, with electromechanical start, may be as much as 2000 Euro.

The reliability and efficiency of the pump speed control systems means optimising consumption and processes as well as savings. In the specific case of pumping appliances, the immediate consequence of the use of these systems is the realisation of pumps with greater operative flexibility, with much larger and optimal performance curves. There are many advantages - above all, a pump that always works, irrespective of variations in the installation, in optimal conditions with less wear and less malfunctions. So there are less problems from downtime and the pumps require less frequent maintenance. Moreover, an installation where the pumps are controlled by an inverter is more efficient and less subject to stress:

- absence of water hammer (which occurs when switching off pumps driven in a traditional way);
- lower working pressures than systems with an autoclave or piezometric tank;
- pressure and flow rate conditions always adequate for the demands, because the inverter is able to adjust the pump gradually in real time according to the pressure trend in the installation.

GVF BOOSTER SETS SERIES ENERGY SAVING

All this results in less stress on all the components in the distribution network, and therefore in less maintenance of the network, greater reliability of supply and lower running costs.

In short, using a pumping system with one or more variable-speed pumps means:

- ✓ Saving energy;
- ✓ Optimising resources and processes;
- ✓ Having the possibility of complete integration of the management, control and supervision systems;
- ✓ Prolonging the life of the installations;
- ✓ Reducing maintenance costs;

Increasing the productivity and efficiency of an installation.

Comparison of starting systems

Having examined the various starting systems that can be realised for electric motors, direct start, star/delta, soft starter and inverter, they can be compared, analysing the absorbed currents and therefore the energy consumed (current = energy = kWh = MONEY).

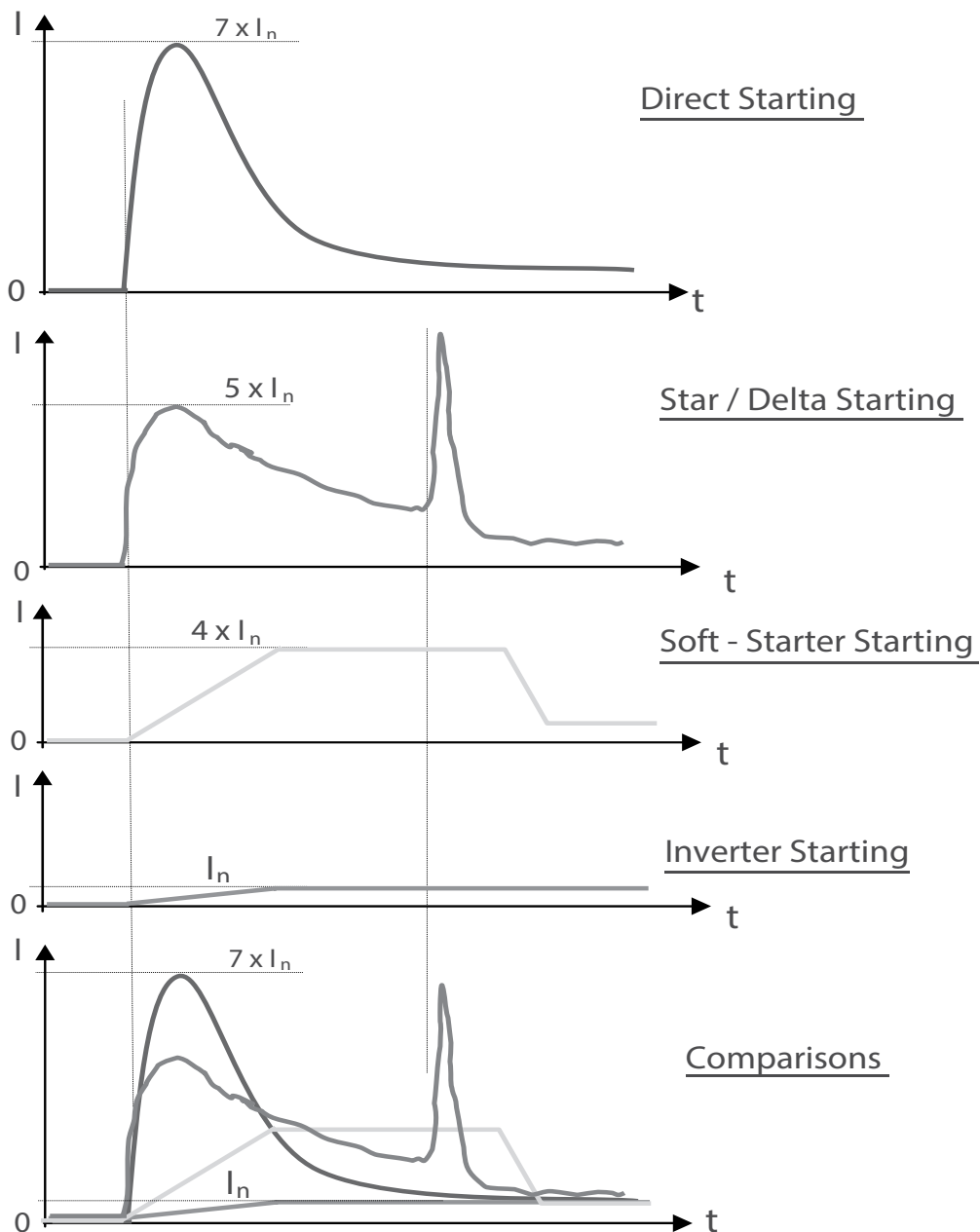

GVF BOOSTER SETS SERIES SELECTING THE PUMPS

The choice of pump is therefore based on the characteristic curve of the pump depending on the flow rate and the pressure required for the system. Starting from the required flow rate, a vertical line is drawn until it meets the horizontal line of the required pressure. The point of intersection of the lines gives both the type and the number of pumps necessary for the system.

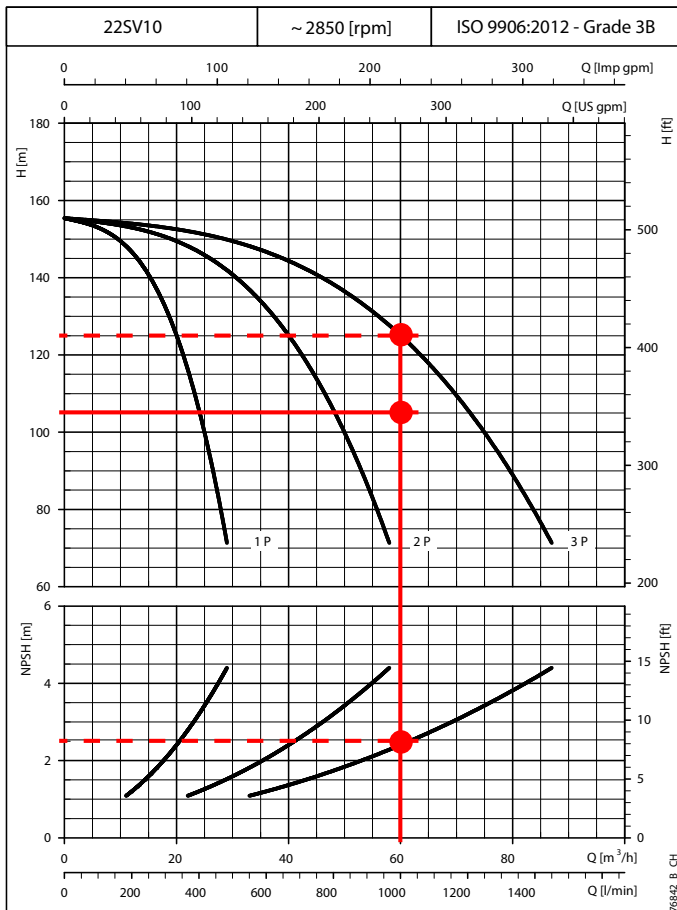

The example alongside refers to a required flow rate of 60 m³/h and a pressure of 105 m water column

As shown in the operating curves on page 85, the selection requires three 22SV10 pumps.

Moreover the take-off point falls in the npsh area farthest to the left and therefore in an area with a low cavitation risk.

The values obtained are those for the performance of the pumps. A correct check of the net pressure value must be made due to the intrinsic load loss of the booster set and the conditions of installation. For this reason it is recommended to see the specific chapter in this catalogue.

NPSH

The minimum operating values that can be reached by the pump suction are limited by the appearance of cavitation. Cavitation consists in the formation of steam pockets in the liquid when the local pressure reaches a critical value.

A critical value is when the local pressure is equal or just below the pressure of the liquid steam.

Steam cavitation flows with the current. When it reaches a higher pressure area, condensation of the contained steam occurs.

The pockets collide, causing pressure waves that are transmitted to the walls, which are therefore subjected to stress cycles that can cause deformation and then breaks due to fatigue.

This phenomena, characterised by a metallic noise due to the hammering of the walls, is called incipient cavitation. Cavitation damage can be made worse by electrochemical corrosion, and by local temperature increases due to the plastic deformation of the walls.

The materials with the highest resistance to heat and corrosion are alloyed steels, and particularly austenitic steels. The conditions that cause cavitation can be predicted by calculating the total suction height, indicated in the technical literature with the acronym NPSH (Net Positive Suction Head).

The NPSH represents the total energy (in m) of the flow measured at the suction in incipient cavitation conditions, net of the steam pressure (in m) of the fluid at the input of the pump.

GVF BOOSTER SETS SERIES SUCTION CONDITIONS

Once the type and the number of pumps of the set have been identified, the suction conditions must also be assessed. Below is an example of the assessment of the suction lift installation conditions, in relation to the previously described case:

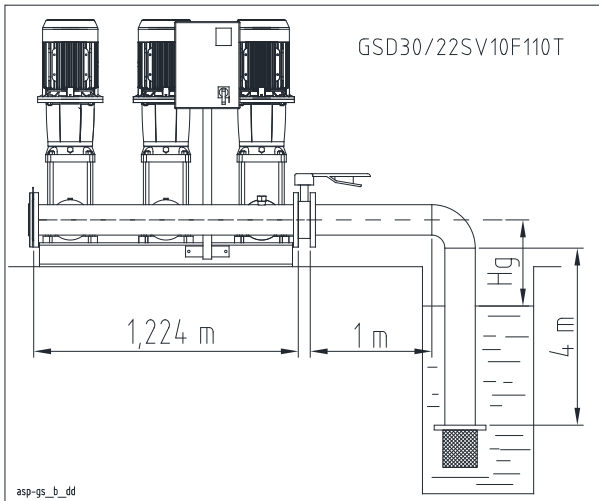

in suction lift installation, it is necessary to calculate the maximum Hg height - which must not be exceeded due to safety reasons -, to avoid cavitation, and therefore the unpriming of the pump itself.

The relation that must be assessed, and which connects this value, is the following:

$NPSH_{available} \geq NPSH_{required}$, when the equality condition represents the limit condition.

$$NPSH_{available} = Patm + Hg - \Sigma t - \Sigma a$$

Where:

Patm is the atmospheric pressure, equal to 10,33 m

Hg is the geodetic level difference

Σt are the pressure drops for suction components such as foot check valve, suction piping, curve, gate valve.

Σa are the pressure drops for suction set branch.

L'NPSH_{requested} is a parameter obtained from the performance curve; in our case, at the flow of each pump equal to 20 m³/h, it corresponds to 2.5 m (page 85). Before calculating the L'NPSH_{available}, it is necessary to calculate the pressure drops at the suction, using the tables on page 115-116, and taking into account the material, such as the type of stainless steel for the piping and cast iron for the valves. The total sum of the pressure drops Σt for suction components is made in the following way, considering that the diameter of the suction piping is DN100, equal to the diameter of the suction manifold of the set (page 59).

Calculation of suction drops Σc for cast iron components:

Equivalent piping length for DN100 foot check valve = 4,7 m

Equivalent piping length for DN100 gate valve = 0,4 m

Total equivalent length = 4,7 + 0,4 = 5,1 m

Pressure drops in the suction piping (cast iron) $\Sigma c = 5,1 \times 7,79 / 100 = 0,39$ m

Calculation of suction drops Σs for stainless steel components:

Equivalent piping length for DN100 90° curve = 2,1 m

Total equivalent length = 2,1 m

Horizontal suction pipe length = 1 m

Vertical suction pipe length = 4 m

Pressure drops in the suction piping (stainless steel) $\Sigma s = (2,1 + 4 + 1) \times 7,79 \times 0,54 / 100 = 0,29$ m

Pressure drops for suction components $\Sigma t = \Sigma c + \Sigma s = 0,39 + 0,29 = 0,68$ m

The total sum of the pressure drops Σt for suction components is made in the following way, considering that the diameter of the suction piping is DN100, equal to the diameter of the suction manifold of the set (page 59). Hc pressure drops for suction set branch must be assessed on the B curve (pag.100, scheme B0401_A_CH); at the flow value of each pump equal to 20 m³/h, a value of Hc = 2,7 m is obtained

Calculation of suction drops Σs for stainless steel components

Equivalent piping length for DN100 manifold T fitting = 4,3 m

Suction manifold length = 1,224 m

Pressure drops in the suction manifold (steel) $\Sigma t = (4,3 + 1,224) \times 7,79 \times 0,54 / 100 = 0,23$ m

Pressure drops $\Sigma a = Hc + \Sigma s = 2,7 + 0,23 = 2,93$ m

Remembering that $NPSH_{available} = Patm + Hg - \Sigma t - \Sigma a$ and that $NPSH_{available} \geq NPSH_{requested}$ we have that $Patm + Hg - \Sigma t - \Sigma a$ must be $\geq NPSH_{requested}$.

Substituting the values we get that $10,33 + Hg - 0,68 - 2,93 \geq 2,5$ m (NPSH_{requested}),

$Hg = 2,5 + 0,68 + 2,93 - 10,33 = -4,9$ m, it represents the limit condition for which

NPSH_{available} = NPSH_{requested}

Therefore, in order to guarantee the conditions for the correct operation of the system as far as cavitation risks, it will be necessary to position the pump above the water level, so that the Hg height is below the limit value of 4,9 m

GVF BOOSTER SETS SERIES NET PRESSURE CALCULATION

When selecting GVF booster sets, the performance levels of the pump must be taken into account. Performance levels are obtained from the characteristic curves of the pumps, and do not take into account any pressure drops due to system piping and valves. The following example helps the customer to obtain the correct delivery manifold pressure value:

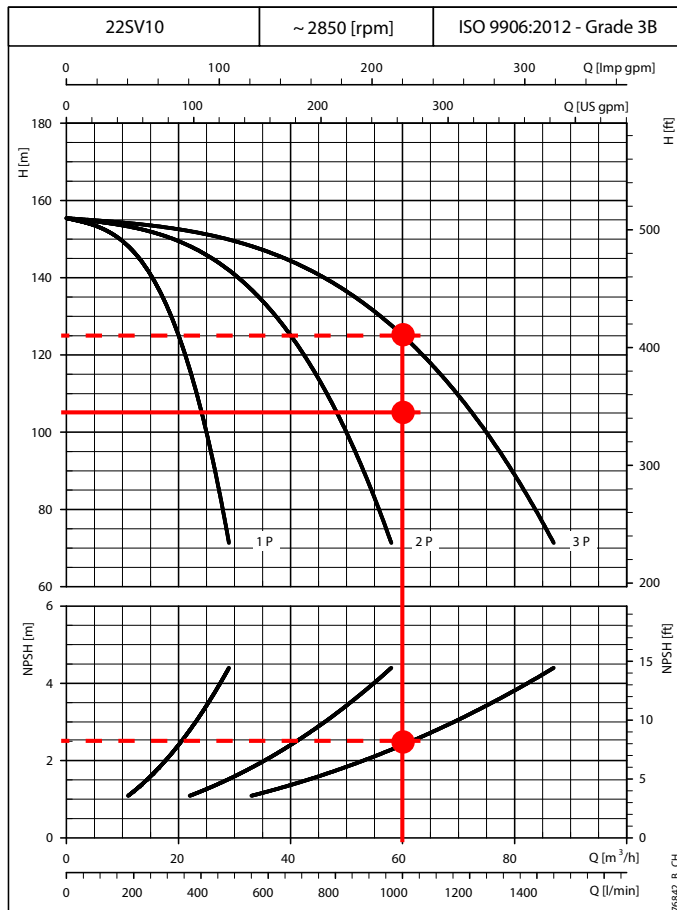

by knowing the system operating point $Q = 60 \text{ m}^3/\text{h}$ and $H = 105 \text{ mca}$ (P requested), and the installation height H_g (estimated to 5 m), in order to make the calculations easier we use the pressure drop curves for each single pump on page 100 of this catalogue. Assuming that a booster set GVF30/22SV with non-return valves on the delivery has been selected, we proceed as follows:

P net available \geq P requested, when the equality condition represents the limit condition.

P net available = $H - (H_g + \Sigma t + \Sigma a + \Sigma m)$
 Where:
 H head value of booster set
 H_g is the geodetic level difference (estimated to 5 m)
 Σt are the pressure drops for suction components such as foot check valve, suction piping, curve and gate valve.
 Σa are the pressure drops for suction set branch
 Σm are the pressure drops for delivery set branch

The total sum of the pressure drops Σt for suction components is made in the following way, considering that the diameter of the suction piping is DN100, equal to the diameter of the suction manifold of the set (page 59).

Calculation of suction drops Σc for cast iron components:
 Equivalent piping length for DN100 foot check valve = 4,7 m
 Equivalent piping length for DN100 gate valve = 0,4 m
 Total equivalent length = 4,7 + 0,4 = 5,1 m
 Pressure drops in the suction piping (cast iron)
 $\Sigma c = 5,1 \times 7,79 / 100 = 0,39 \text{ m}$

Calculation of suction drops Σs for stainless steel components:
 Equivalent piping length for DN100 90° curve = 2,1 m
 Total equivalent length = 2,1 m
 Horizontal suction pipe length = 1 m
 Vertical suction pipe length = 4 m
 Pressure drops in the suction piping (stainless steel) $\Sigma s = (2,1 + 4 + 1) \times 7,79 \times 0,54 / 100 = 0,29 \text{ m}$

Pressure drops for suction components $\Sigma t = \Sigma c + \Sigma s = 0,39 + 0,29 = 0,68 \text{ m}$
 The total sum of the pressure drops Σt for suction components is made in the following way, considering that the diameter of the suction piping is DN100, equal to the diameter of the suction manifold of the set (page 59). H_c pressure drops for suction set branch must be assessed on the B curve (pag.100, scheme B0401_A_CH); at the flow value of each pump equal to $20 \text{ m}^3/\text{h}$, a value of $H_c = 2,7 \text{ m}$ is obtained.

GVF BOOSTER SETS SERIES NET PRESSURE CALCULATION

Calculation of suction drops Σs for stainless steel components:

Equivalent piping length for DN100 manifold T fitting = 4,3 m

Suction manifold length = 1,224 m

Pressure drops in the suction manifold (steel) $\Sigma t = (4,3 + 1,224) \times 7,79 \times 0,54 / 100 = 0,23$ m

Pressure drops $\Sigma a = H_c + \Sigma s = 2,7 + 0,23 = 2,93$ m

The total sum of the pressure drops Σm for delivery branch is made in the following way, considering that the diameter of the delivery manifold is DN100, equal to the diameter of the delivery manifold of the set (page 59). H_c pressure drops for delivery set branch must be assessed on the A curve (pag.100 scheme B0401_A_CH); at the flow value of each pump equal to 20 m³/h, a value of $H_c = 0,0034$ m is obtained

Calculation of delivery drops Σs for stainless steel components:

Equivalent piping length for DN100 manifold TEE fitting = 4,3 m

Delivery manifold length = 1,224 m

Pressure drops in the delivery manifold (steel) $\Sigma s = (4,3 + 1,224) \times 7,79 \times 0,54 / 100 = 0,23$ m

Pressure drops in delivery manifold $\Sigma m = H_c + \Sigma s = 0,0034 + 0,23 = 0,2334$ m

If we analyse the performance of the set at the flow value of 60 m³/h, the head value H is 125 m.

The net pressure at the delivery manifold will be $P_{\text{net available}} = H - (H_g + \Sigma t + \Sigma a + \Sigma m)$

Substituting the values we get that $P_{\text{net available}} = 125 - (5 + 0,68 + 2,93 + 0,2334) = 123,84$ m

When comparing this value with the design value (not taking into account the dynamic energy) we see that 123,84 m > 105 m [$P_{\text{net available}} > P_{\text{Required}}$]

The set is therefore capable of meeting system requirements.

GVF.../SV Series

Variable-speed booster sets with e-SV™ series
Vertical Multistage Electric Pumps with
high-efficiency motors and
flow rates up to 640 m³/h

50 Hz

GVF BOOSTER SETS SERIES SET IDENTIFICATION CODE

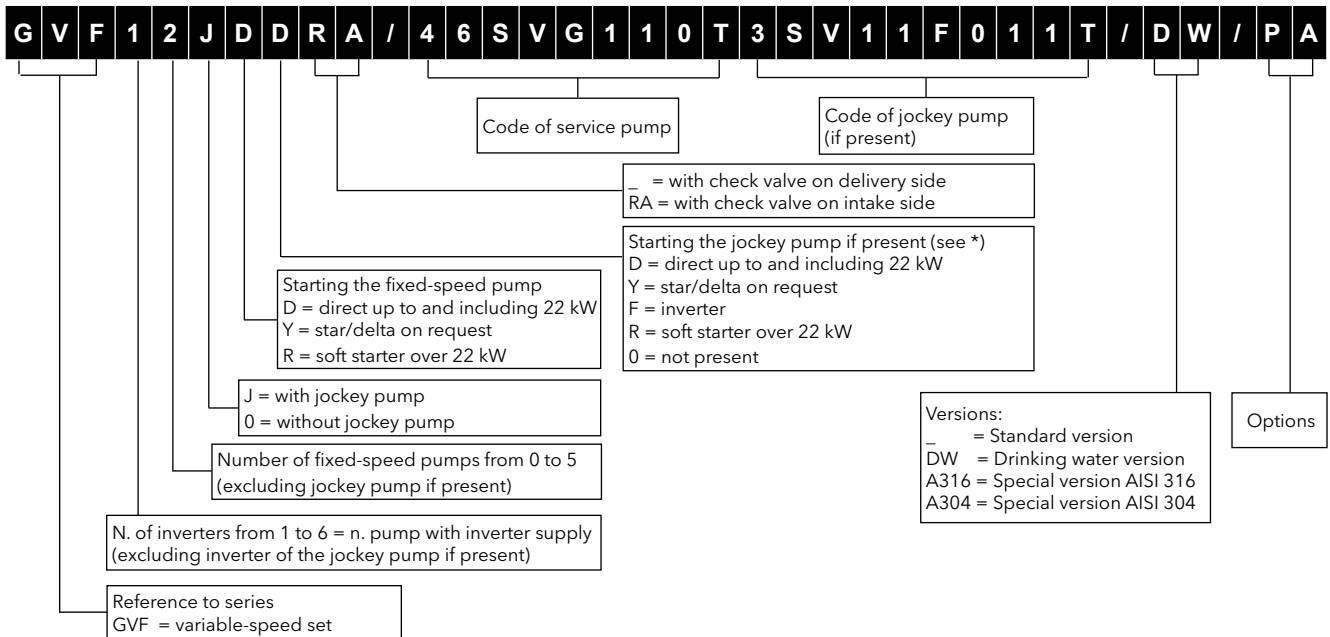

VERSIONS AVAILABLE

- A304 Main components in contact with the liquid in AISI 304 stainless steel or higher. Galvanised screws and bolts. Flanges not in contact with the liquid galvanised (Available in the Z version).
- B304 Main components in contact with the liquid in AISI 304 stainless steel or higher. Screws and bolts in AISI 304 stainless steel or higher. Flanges not in contact with the liquid in AISI 304 stainless steel (Available in the Z version).
- C304 Main components in contact with the liquid in AISI 304 stainless steel or higher. Base, brackets, supports, screws and bolts in AISI 304 stainless steel or higher. Flanges not in contact with the liquid in AISI 304 stainless steel or higher. Valves fully made of AISI 304 stainless steel or higher (body, heads, disc) (Available in the Z version).
- A316 Main components in contact with the liquid in AISI 316 stainless steel or higher. Galvanised screws and bolts. Flanges not in contact with the liquid galvanised (Available in the Z version).
- B316 Main components in contact with the liquid in AISI 316 stainless steel. Screws and bolts in AISI 316 stainless steel. Flanges not in contact with the liquid in AISI 316 stainless steel (Available in the Z version).
- C316 Main components in contact with the liquid in AISI 316 stainless steel. Base, brackets, supports, screws and bolts in AISI 316 stainless steel. Flanges not in contact with the liquid in AISI 316 stainless steel. Valves fully made of AISI 316 stainless steel (body, heads, disc)

OPZIONI (ON DEMAND)

- 3A Set with 1A certified pumps (Factory test report issued from end of line, QH curve included).
- 3B Set with 1B certified pumps (Test bulletin issued by Sala Audit (Audit Room); it includes QH curve, output and power).
- 60 Set operating frequency 60 Hz, electric pumps with 60Hz motor. Maximum HYDROVAR[®] output frequency set at 60Hz.
- BAP High pressure switch on the delivery manifold.
- C9 Delivery manifold turned by 90°, curves. It is not possible to install expansion vessels directly on the manifold.
- CM Suction or delivery manifold larger than standard size.
- CP Control panel with clean contacts: converter faulty, operation/stop for each pump.
- P65 IP65 protection degree control panel.
- KV Kit voltmeter.
- MA Pressure gauge installed on suction manifold.
- NL Dutch market version.
- PA Minimum pressure gauge installed on the suction
- PQ Set for aqueduct installation (with pressure gauge/ pressure switches/transmitters oversized by one size).
- RA Non-return valve mounted on suction valve (Es. GVF20RA/SV...).
- RE Control panel with condensation resistance, controlled by a thermostat.
- SA Without suction: without suction valves and without suction manifold.
- SC Set without control devices such as pressure switches and transmitters; with pressure gauge.
- SCA Without suction manifold (but with suction valves).
- TS Set with electric pumps with special seals.
- UK UK market version .
- VA Control panel with digital voltmeter and ammeter.
- WM Wall mounted control panel; cables L=5m.
- PP Control by pressure switch; in the case of malfunction of the trasmitters, the set runs at fixed speed (if enabled).

GVF BOOSTER SETS SERIES ELECTRIC CONTROL PANEL AND SD60 CONTROL UNIT

Electric panel or the supply, control and protection of, at most, six three-phase electric pumps, with sheet steel case (fig. 1) and protection rating IP55.

Main characteristics:

- Main door-blocking switch, fuse carrier and fuses, starting contactors and thermal protection.
- Standard supply voltage: 3x400Vac +/-10%, 50/60Hz. Non standard voltages on request, 1x230Vac +/-10%, 3x230Vca +/-10%, 50/60Hz.
- Transformer for low voltage auxiliary circuit; auxiliary voltage 24Vac.
- Inside, depending on the type of control variation, one or more frequency converters.

SD60 digital control unit, with microprocessors, with graphic display and programming keys (see fig. 2).

The SD60 is a programmable electronic controller with high connectivity and flexibility for regulating and monitoring variable-speed pressure boosting sets.

The controller offers the following characteristics and functions:

- Graphic display type o-led 2,7". The graphic display can show the state of the system, of the individual pump, the alarms log, one or more alarms in progress, the state of the digital inputs and outputs, the value of the analog inputs and outputs, the running hours of each pump installed or other elements depending on the menu.
- Multi-language.
- Indicating leds: automatic/manual operating mode (ref. 1), line presence (ref. 2), general fault (ref. 3), alarm level for water lack on suction side (ref. 4), pump running (ref. 5).
- Programming and menu browsing touch keys, type cap - sense back-lit.
- Manual adjustment of the output frequency, at the motor, of each inverter (jog mode).
- Manual starting of each fixed-speed pump.
- Management of a jockey pump and of a standby pump.
- Management of up to a maximum of six working set points.
- Management of frequency converter operation.
- Timing on starting and stopping of each installed pump.
- Cyclical exchange of starting of the variable-speed pump and of the fixed-speed pumps, to guarantee uniform wear of all the installed pumps.
- Two(2) analog inputs in current 0(4)-20mA for the connection of electronic sensors (pressure, flow rate, level, temperature, ...).
- One (1) analog input in current 0(4)-20mA and one (1) output in voltage 0(2)-10Vdc. The functions of the analog outputs are programmable.
- Dedicated inputs for the connection of the low level control device, low pressure on suction side of the pump set. The device may be chosen from: minimum pressure switch, float, three electric probes.
- Digital relay outputs for pump control.
- One (1) dedicated digital relay output, with two exchanging contacts, programmable type. Depending on the devices connected, there may be the following alarm signals: low level on suction side, motor overload, faulty sensor, faulty inverter, maximum and minimum pressure on pump set delivery side, fault due to general external device (excess voltage, insufficient voltage of power supply line, ...).

fig. 1

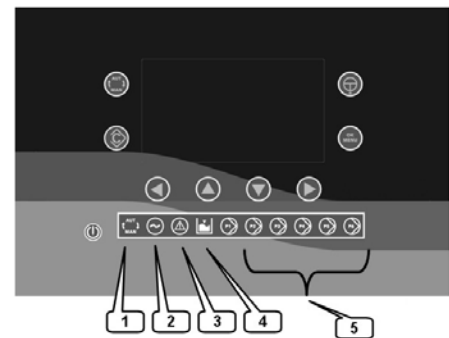
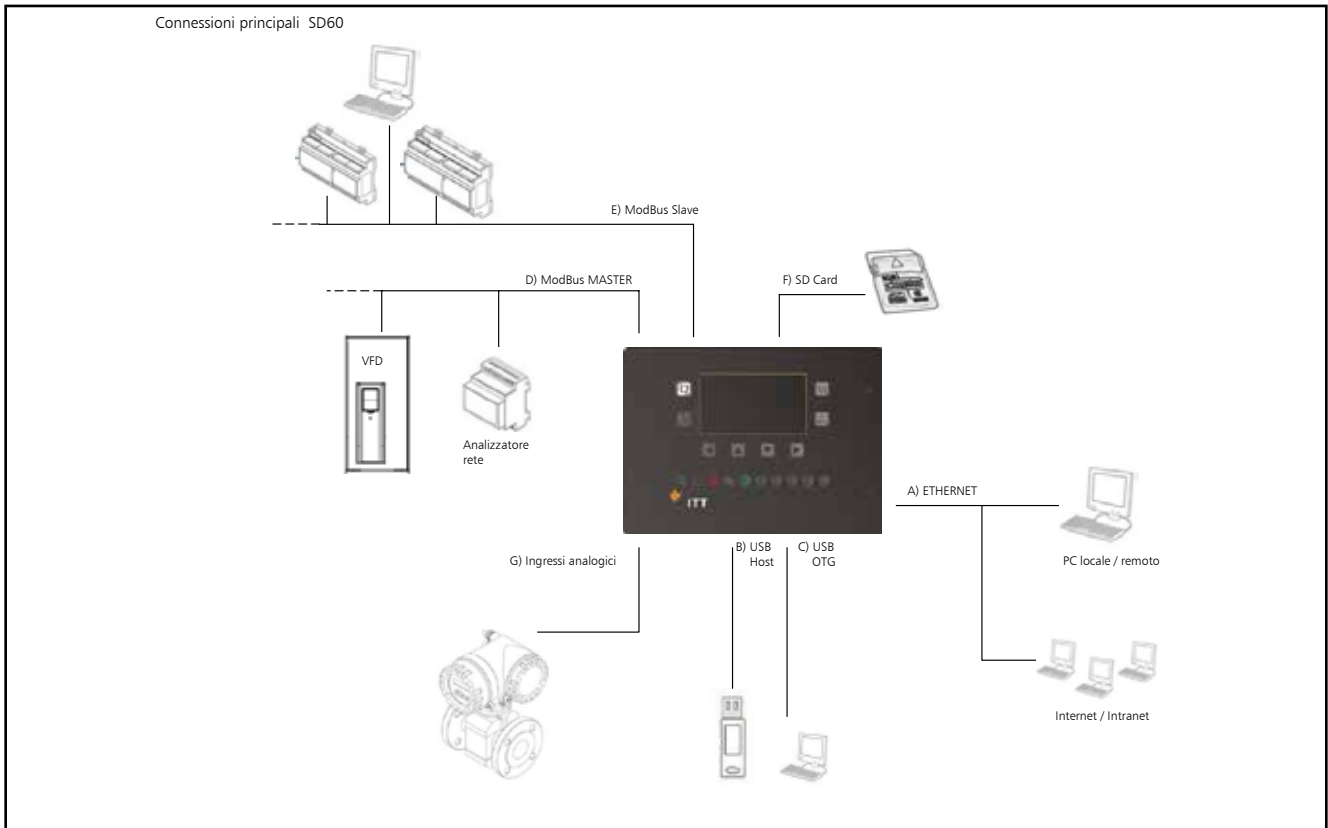

fig. 2

GVF BOOSTER SETS SERIES ELECTRIC CONTROL PANEL AND SD60 CONTROL UNIT

- One (1) dedicated digital relay output, with two exchanging contacts, programmable. Depending on the devices connected, there may be the following signals: set running, inverter running, autotest in progress.
- Dedicated optoinsulated digital inputs for the connection of the running pump contacts, thermal protection.
- Optoinsulated digital inputs, programmable according to the type of protection and control devices connected (PTC, maximum pressure switch, external alarm, faulty inverter, remote consent, change set point, ...).
- Thanks to the large capacity of the flash memory and to the clock with RCT buffer battery, it is possible to memorise all the alarms that occur, the value of the main physical characteristics regulated (pressure, flow rate, ...) and the state of the installed pumps. The data can be transferred to USB stick or to a PC, also by means of USB ports or ETHERNET. Two high-performance 16 bit microprocessors guarantee high speed of execution of the program and efficient interface management.
All the important parameters are password-protected.
- Compatibility with supervision and control systems is becoming more and more important. For this reason the SD60 unit is equipped as standard with two (2) optoinsulated serial interfaces, for connection with the most widespread BMS supervision and control systems or with applications developed by third parties. Standard communication protocols are of the ModBus RTU.
It is also possible to interface with other supervision systems that use other communication protocols (BacNet™, Johnson Metasys®, TCP/IP, LonWorks®, Trend...) by means of optional external modules, available on request.
- Thanks to the web server and to the P_LAN gateway, it is possible to interface with intranet/internet networks.
- Slot for inserting memory card Micro SD card Max 2 Giga. Secure Digital (referred to briefly as SD) is the most widespread form of memory card, electronic devices used to store large quantities of information in digital format in flash memories. The user can therefore choose to save the event log data in the memory card (not included) instead of in the flash ram of the SD60 unit.
- One (1) USB port, Host type, for connecting devices such as a USB stick (also known as USB flash drive, USB pen, pendrive...): it is possible to transfer data such as the configuration files of the SD60 unit, the events log ("csv" format) or to import files such as software updates.
- One (1) USB OTG port for displaying, exporting (saving on PC) configuration files and the events log and for importing (saving on SD60) the configuration file, software updates.
- To guarantee greater safety and more simple maintenance of the pressure boosting systems, the SD60 unit can be provided with a serial connection to the electronic mains analysing module. This module allows monitoring of all the electric values of the pump set electric supply line, including energy consumed. The data can be exported in a file.
- Provision for connection with an optional module with 5 digital outputs, each one programmable, each with final electric contact of the type NO normally open (on request, module with electric contact NC).
Signals available:
Automatic/Manual system mode, pump no. running, Thermal protection tripped pump no., low level/minimum pressure alarm on suction side of set, maximum and minimum pressure alarm on delivery side of set, external alarm, autotest failed, line presence, inverter running.

GVF BOOSTER SETS SERIES CONNECTIONS OF SD60 CONTROL UNIT



Key:

- A) LAN port, Ethernet 10/100 integrated in the board, connector RJ45. It is possible to configure, display and control on a PC the state of operation of the pump set in a local Intranet network or even on the Internet, if accesses are enabled. The SD60 unit has as a standard feature (the Web server application) which allows a computer to be connected by Ethernet to the SD60 unit. It is therefore possible to export the user interface from the SD60 unit to a PC to allow external monitoring and control of the unit and, consequently, of the system.
- B) USB port, Host type. It is possible to connect only devices such as a USB stick (also called USB flash drive, USB PEN, pendrive) to this port. With this device it is possible to export files such as the configuration file of the SD60 unit, the events log ("csv" format) or to import files such as software updates.
- C) USB OTG port for connection to PC. With this device it is possible to display, export files (save on PC), such as the configuration file of the SD60 unit, the events log ("csv" format) or to import files such as software updates.
- D) ModBus Serial port, Master type on hardware RS485. The serial interface is for communication between the SD60 controller and the inverters of the pump set, the mains analyser and, if present, expansion modules such as the module for boosting dry digital contacts. Standard communication protocol type ModBus RTU with possibility of setting the following parameters by software: BAUD RATE, PARITY CONTROL, STOP BIT.
- E) ModBus Serial port, Slave type on hardware RS485. The serial interface is for communication between the SD60 controller and the supervision systems. Standard communication protocol type ModBus RTU with possibility of setting the following parameters by software: ADDRESS, BAUD RATE, PARITY CONTROL, STOP BIT.
- F) The SD60 unit is equipped, as hardware, with a slot for inserting the memory card Micro SD card Max 2 GB. Secure Digital (referred to briefly as SD).
- G) Standard features, four configurable analog inputs. Standard, two inputs exclusively for connection to pressure sensors, one active and one in standby with automatic activation in the event of malfunction of the main sensor.

**GVF-GVM SERIES
SPECIAL VERSIONS WITH 5/6 PUMPS**

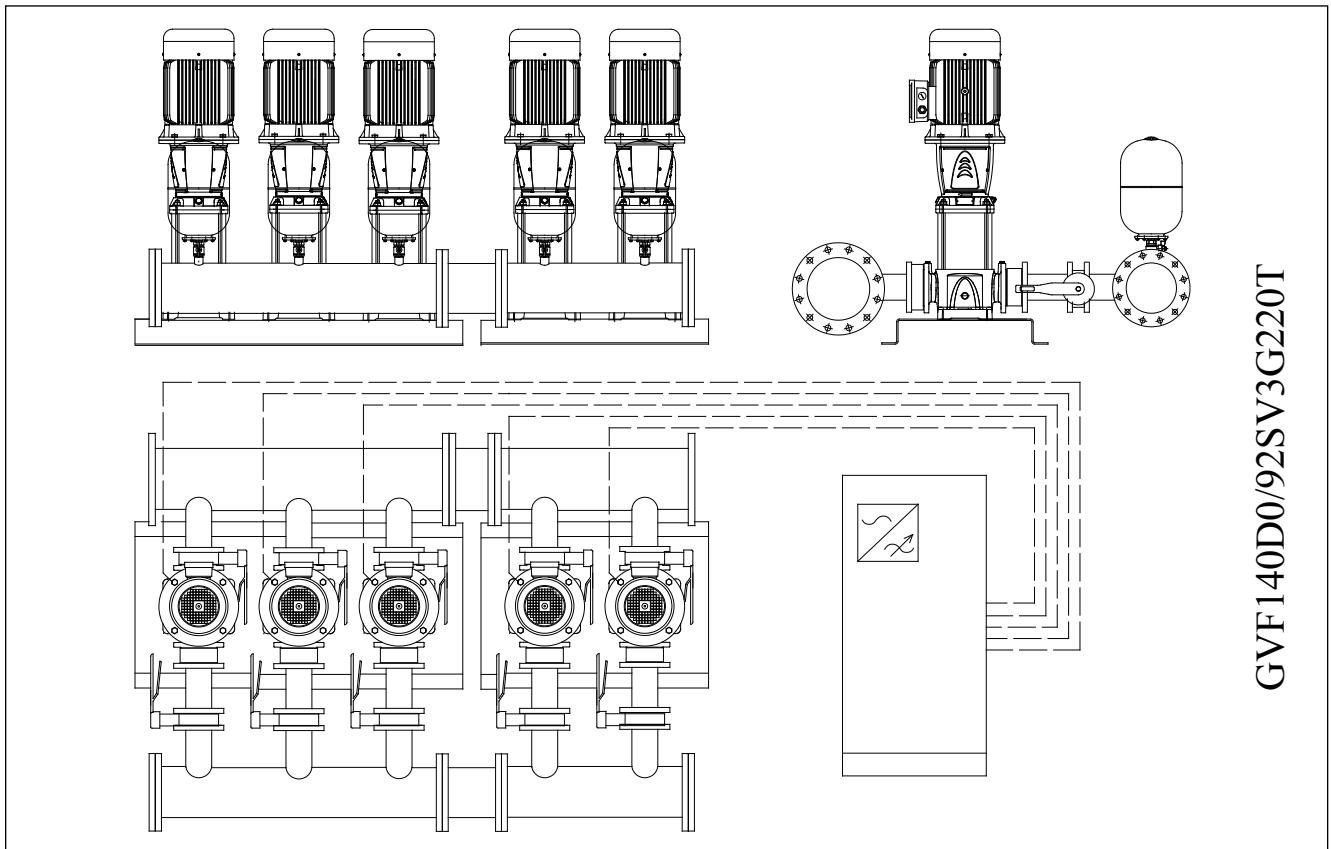

GVF140D0/92SV3G220T

N.B.: Please request other special versions with regard to materials used, working temperatures, electric panels with additional functions.

**GVF.../SV SERIES
HYDRAULIC PERFORMANCE RANGE**

GVF.../SV

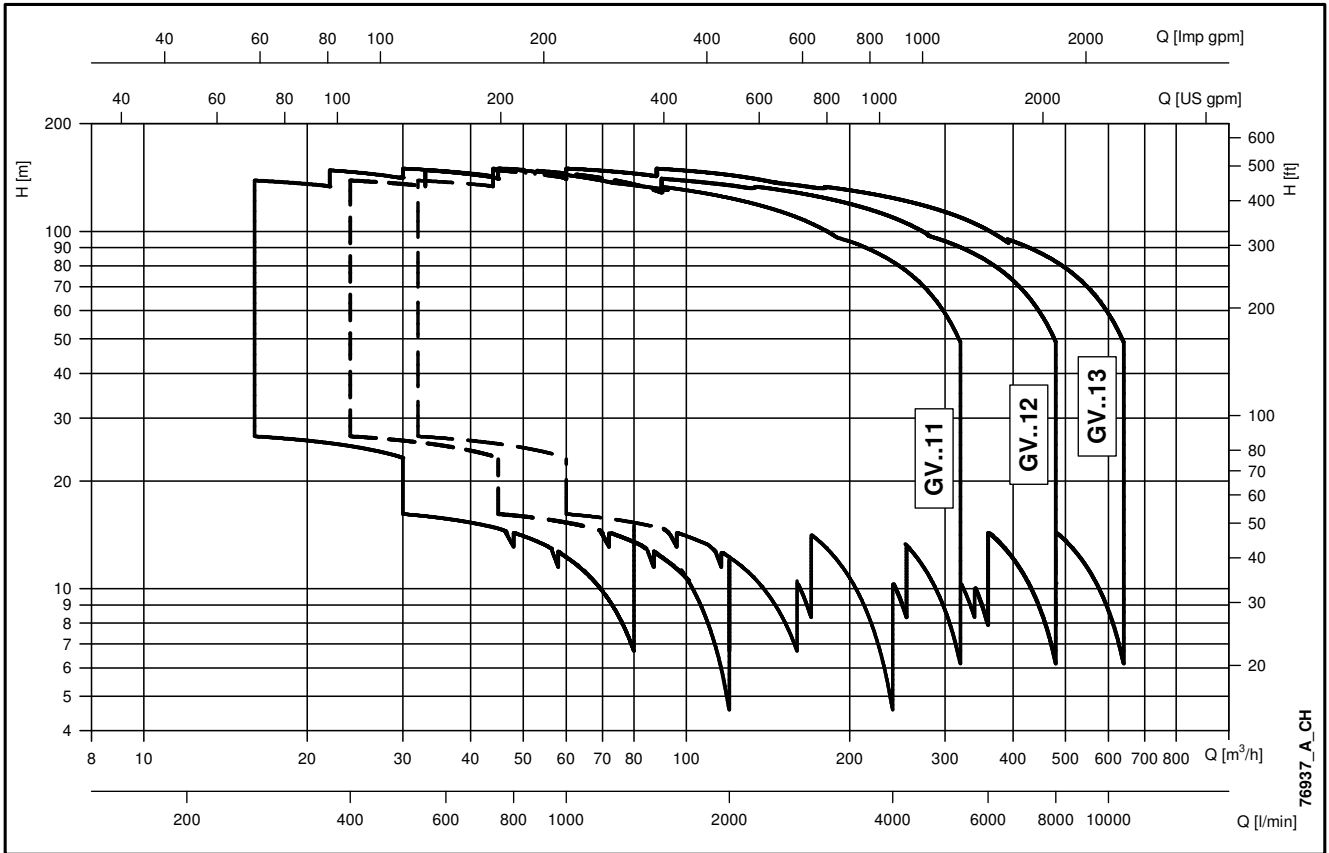

76937_A_CH

GVF BOOSTER SETS SERIES RANGE

The range of GVF series variable-speed booster sets includes models with 2 to 4 electric duty pumps to adapt to the specific needs of each application.

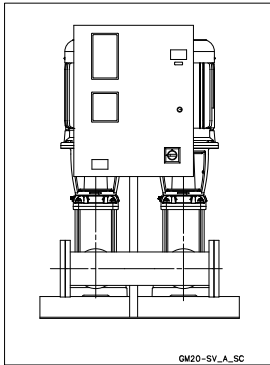

GVF11 SETS

- Variable-speed sets with two multistage vertical service pumps, SV series, with power ratings up to 37 kW.

Head up to 160m.
Flow rate up to 320 m³/h.

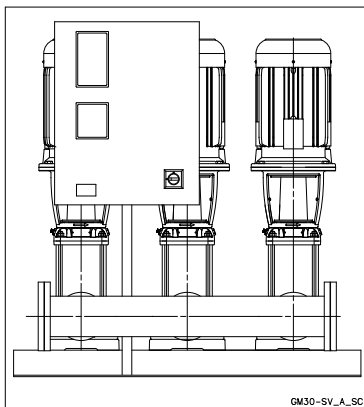

GVF12 SETS

- Variable-speed sets with three multistage vertical service pumps, SV series, with power ratings up to 37 kW.

Head up to 160m.
Flow rate up to 480 m³/h.

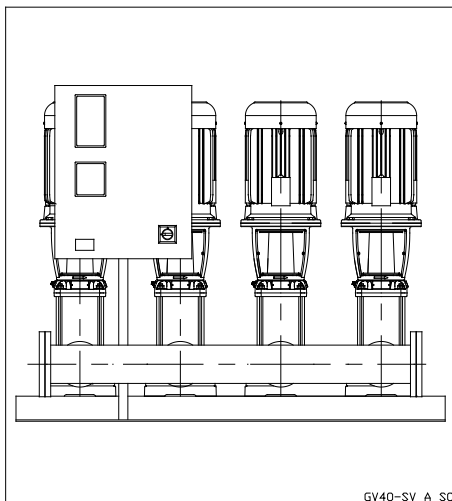

GVF13 SETS

- Variable-speed sets with four multistage vertical service pumps, SV series, with power ratings up to 37 kW.

Head up to 160m.
Flow rate up to 640 m³/h.

ELECTRIC PUMPS GENERAL DESCRIPTION

The **e-SV** pump is a multistage vertical pump, not self-priming, combined with a normalised standard motor. The liquid end, located between the upper cover end the pump casing, is held in place by tie rods. The pump casing is available with different configurations and connection types.

GVF.../SV



Technical Information:

Flow rates: up to 160 m³/h.
Heads: up to 160 m.
(referred to the pump range used in this catalogue).

Temperature of pumped liquid:
from -30°C to +120°C (standard version).

Tested to ISO 9906:2012 - Grade 3B
(ex ISO 9906:1999 - annex A).

Direction of rotation: clockwise looking at the pump from the top down (indicated with an arrow on the bracket and joint).

Mechanical seal: Silicon carbide/Carbon/EPDM.
e-SV pumps (only for 10, 15, 22SV \geq 5,5 kW and 33, 46, 66, 92, 125SV) are fitted standard with a balanced mechanical seal that can be replaced without having to remove the motor from the pump.

Elastomers: EPDM.

Motor

Supplied IE3 three-phase surface motors \geq 0,75 kW as standard.

Electrical performances according to EN 60034-1.

Insulation class 155 (F).

IP55 protection.

Condensate drain plugs on standard version.

Cooling by fan according to EN 60034-6.

Cable gland metric size according to EN 50262.

Standard supplied e-SV electric pumps are equipped with Standard motors.

Standard voltage:

- **Three-phase version:** 220-240/380-415 V 50 Hz. \leq 3kW
380-415/660-690 V 50 Hz. $>$ 3kW

For electrical data of the motors used see page 24.

Materials

The pumps for F, T, R, N, G versions are certified for drinking water use (**WRAS, ACS and D.M.174.**)

For complete information see dedicated e-SV technical catalogue.

ELECTRIC PUMPS 3, 5, 10, 15, 22SV SERIES CHARACTERISTICS

- Multistage centrifugal vertical electric pumps. All metal parts in contact with pumped liquid are made of stainless steel.
- **F** version: round flanges, in-line delivery and suction ports, AISI 304 stainless steel.
- Further choice possibilities among the following versions:
 - **T**: oval flanges, in-line delivery and suction ports, AISI 304 stainless steel.
 - **R**: round flanges, delivery port above the suction port and adjustable in four positions, AISI 304 stainless steel.
 - **N**: round flanges, in-line delivery and suction ports, AISI 316 stainless steel.
- Reduced axial thrusts enable the use of **standard motors** that are easily found on the market.
- Standard mechanical seal according to EN 12756 (formerly DIN 24960) and ISO 3069 for series 1, 3, 5SV and 10, 15, 22SV ($\leq di$ 4 kW).
- **Balanced mechanical seal** according to EN 12756 (formerly DIN 24960) and ISO 3069, easy to replace **without removing the pump motor**, for series 10, 15 and 22SV ($\geq di$ 5,5 kW).
- Seal housing designed to avoid air accumulation inside the critical area adjoining the mechanical seal.
- Second loading plug available for series 10, 15, 22SV.
- Easy maintenance. No special tools required for assembly or disassembly.

F, T, R and N pumps are certified for use with drinking water (WRAS, ACS and D.M.174.)

33, 46, 66, 92, 125SV SERIES CHARACTERISTICS

- Version **G**: Multistage vertical centrifugal electric pump with impellers, diffusers and outer jacket fully made of stainless steel; superior cast iron pump body and head. Round flanges, in-line delivery and suction ports.
- Further choice possibilities among the following versions:
 - **N, P**: fully made of AISI 316 stainless steel.
- In pumps with higher heads, the axial load compensation system allows a reduction of axial thrusts, and therefore the use of **normalised standard motors**, easy to find on the market.
- **Balanced mechanical seal** according to EN 12756 (formerly DIN 24960) and ISO 3069, **easy to replace without removing the pump motor**.
- Seal housing designed to avoid air accumulation inside the critical area adjoining the mechanical seal.
- Pump body supplied with the necessary attachments for a pressure gauge on the flanges, both on the suction and the delivery side.
- Mechanical strength and easy maintenance. No special tools required for assembly or disassembly.

G and N pumps are certified for use with drinking water (WRAS, ACS and D.M.174.)

ELECTRIC PUMPS THREE-PHASE MOTORS, 2-POLE (up to 22 kW)

P _N kW	Efficiency η_N %																		IE	Year of manufacture
	Δ 220 V Y 380 V			Δ 230 V Y 400 V			Δ 240 V Y 415 V			Δ 380 V Y 660 V			Δ 400 V Y 690 V			Δ 415 V				
	4/4	3/4	2/4	4/4	3/4	2/4	4/4	3/4	2/4	4/4	3/4	2/4	4/4	3/4	2/4	4/4	3/4	2/4		
0,37	-	-	-	-	-	-	-	-	-	-	-	-	-	-	-	-	-	-	-	-
0,55	-	-	-	-	-	-	-	-	-	-	-	-	-	-	-	-	-	-	-	-
0,75	82,5	83,1	81,3	82,8	82,7	80,1	82,6	82,0	78,9	82,5	82,0	78,9	82,5	82,0	78,9	82,5	82,0	78,9	-	-
1,1	84,0	84,7	83,4	84,4	84,5	82,5	84,3	84,0	81,4	84,0	84,0	81,4	84,0	84,0	81,4	84,0	84,0	81,4	-	-
1,5	85,6	86,5	85,8	85,9	86,4	84,9	86,0	86,0	84,0	85,6	86,0	84,0	85,6	86,0	84,0	85,6	86,0	84,0	-	-
2,2	86,5	87,4	86,8	86,4	86,9	85,7	86,6	86,7	85,0	86,4	86,7	85,0	86,4	86,7	85,0	86,4	86,7	85,0	-	-
3	87,2	88,5	88,3	87,5	88,2	87,5	87,5	87,8	86,4	87,2	87,8	86,4	87,2	87,8	86,4	87,2	87,8	86,4	-	-
4	89,1	90,1	89,2	89,1	90,1	89,2	89,1	90,1	89,2	89,1	90,3	90,4	89,6	90,4	89,9	89,6	90,1	89,2	-	-
5,5	89,5	89,6	88,0	89,5	89,6	88,0	89,5	89,6	88,0	89,5	90,3	89,9	89,7	90,0	89,0	89,6	89,6	88,0	-	-
7,5	90,6	90,5	89,0	90,6	90,5	89,0	90,6	90,5	89,0	90,6	91,0	90,2	90,8	90,8	89,6	90,7	90,5	89,0	-	-
11	91,3	92,0	91,1	91,3	92,0	91,1	91,3	92,0	91,1	91,3	92,2	92,2	91,6	92,2	91,7	91,7	92,0	91,1	-	-
15	92,5	92,4	91,2	92,5	92,4	91,2	92,5	92,4	91,2	92,7	93,3	92,9	93,1	93,3	92,7	92,5	92,4	91,2	-	-
18,5	92,6	93,1	92,4	92,6	93,1	92,4	92,6	93,1	92,4	92,6	93,2	93,0	92,9	93,3	92,8	92,9	93,1	92,4	-	-
22	93,0	92,7	91,3	93,0	92,7	91,3	93,0	92,7	91,3	93,0	93,2	92,4	93,1	93,0	91,9	93,0	92,7	91,3	-	-

P _N kW	Manufacturer		IEC SIZE*	Construction Design	N. of Poles	f _N Hz	Data for 400 V / 50 Hz Voltage				
	Xylem Service Italia Srl Reg. No. 07520560967 Montecchio Maggiore Vicenza - Italia						cos ϕ	I _s / I _N	T _N Nm	T _s /T _N	T _m /T _N
	Model										
0,37	SM71RB14/304		71R	V18/B14	2	50	0,64	4,35	1,37	4,14	4,10
0,55	SM71B14/305		71				0,74	5,97	1,85	3,74	3,56
0,75	SM80B14/307 PE		80				0,78	7,38	2,48	3,57	3,75
1,1	SM80B14/311 PE		80				0,79	8,31	3,63	3,95	3,95
1,5	SM90RB14/315 PE		90R				0,80	8,80	4,96	4,31	4,10
2,2	PLM90B14/322 E3		90				0,80	8,77	7,28	3,72	3,70
3	PLM100RB14/330 E3		100R				0,79	7,81	9,93	4,26	3,94
4	PLM112RB14S6/340 E3		112R				0,85	9,13	13,2	3,82	4,32
5,5	PLM132RB5/355 E3		132R				0,85	10,5	18,1	4,74	5,11
7,5	PLM132B5/375 E3		132				0,85	10,2	24,4	3,43	4,76
11	PLM160RB5/3110 E3		160R				0,86	9,89	35,9	3,46	4,59
15	PLM160B5/3150 E3		160				0,88	9,51	48,6	2,73	4,32
18,5	PLM160B5/3185 E3		160				0,88	9,81	59,9	2,81	4,53
22	PLM180RB5/3220 E3		180R				0,85	10,9	71,1	3,26	5,12

P _N kW	Voltage U _N V										n _N min ⁻¹	Observe the regulations and codes locally in force regarding sorted waste disposal.	Operating conditions **			
	Δ			Y			Δ			Y			Altitude Above Sea Level (m)	T. amb min/max °C	ATEX	
	220 V	230 V	240 V	380 V	400 V	415 V	380 V	400 V	415 V	660 V						690 V
0,37	2,03	2,18	2,32	1,17	1,26	1,34	-	-	-	-	-	2745 ÷ 2800	≤ 1000	-15 / 40	No	
0,55	2,56	2,56	2,62	1,48	1,48	1,51	-	-	-	-	-	2825 ÷ 2850				
0,75	2,96	2,94	2,96	1,71	1,70	1,71	1,70	1,69	1,70	0,98	0,98	2875 ÷ 2895				
1,1	4,19	4,14	4,16	2,42	2,39	2,40	2,41	2,38	2,38	1,39	1,37	2870 ÷ 2900				
1,5	5,56	5,49	5,51	3,21	3,17	3,18	3,21	3,18	3,19	1,85	1,84	2870 ÷ 2895				
2,2	7,97	7,90	7,98	4,6	4,56	4,61	4,57	4,54	4,57	2,64	2,62	2880 ÷ 2900				
3	11,0	11,0	11,2	6,35	6,33	6,44	6,29	6,27	6,34	3,63	3,62	2865 ÷ 2895				
4	13,6	13,4	13,4	7,87	7,75	7,74	7,80	7,62	7,61	4,50	4,40	2885 ÷ 2910				
5,5	18,1	17,9	18,1	10,4	10,4	10,4	10,6	10,5	10,7	6,10	6,05	2880 ÷ 2910				
7,5	24,8	24,4	24,3	14,3	14,1	14,0	14,4	14,1	14,2	8,32	8,16	2920 ÷ 2935				
11	35,7	35,0	34,9	20,6	20,2	20,2	20,6	20,2	20,2	11,9	11,7	2910 ÷ 2930				
15	47,6	46,1	45,2	27,5	26,6	26,1	27,5	26,6	26,1	15,9	15,3	2940 ÷ 2950				
18,5	58,3	56,7	55,6	33,7	32,7	32,1	34,0	33,0	32,7	19,6	19,0	2940 ÷ 2950				
22	72,9	73,1	73,7	42,1	42,2	42,6	40,9	40,4	40,6	23,6	23,3	2950 ÷ 2960				

* R = Reduced size of motor casing as compared to shaft extension and flange.

sv-IE3-mott22-2p50-en_a_te

** Operating conditions to be referred to motor only. About electric pump, refer to limits in user's manual.

ELECTRIC PUMPS THREE-PHASE MOTORS, 2-POLE (from 30 to 55 kW)

P _N kW	Efficiency η_N %									IE	Year of manufacture
	Δ 380 V Y 660 V			Δ 400 V Y 690 V			Δ 415 V				
	4/4	3/4	2/4	4/4	3/4	2/4	4/4	3/4	2/4		
30	94,0	94,0	93,1	94,1	94,0	92,8	94,2	93,9	92,6	3	From 11/2014
37	94,4	94,0	93,5	94,6	94,0	93,3	94,7	93,9	93,1		
45	94,8	94,9	94,6	95,1	95,1	94,6	95,3	95,2	94,5		
55	95,1	95,0	94,9	95,4	95,3	94,9	95,5	95,3	94,8		

P _N kW	Manufacturer		IEC SIZE	Construction Design	N. of Poles	f _N Hz	Data for 400 V / 50 Hz Voltage				
	WEG Equipamentos Eletricos S.A. Reg. No. 07.175.725/0010-50 Jaragua do Sul - SC (Brazil)						cos ϕ	I _s / I _N	T _N Nm	T _s /T _N	T _m /T _N
	Model										
30	W22 200L V1 30KW E3		200	V1	2	50	0,86	7,30	96,60	2,60	2,90
37	W22 200L V1 37KW E3		200				0,86	7,30	119,2	2,60	2,90
45	W22 225S/M V1 45KW E3		225				0,88	8,00	144,7	2,70	3,20
55	W22 250S/M V1 55KW E3		250				0,89	7,90	177,1	2,80	2,90

P _N kW	Voltage U _N V					n _N min ⁻¹	See note.	Operating conditions **		
	Δ			Y				Altitude Above Sea Level (m)	T. amb min/max °C	ATEX
	380 V	400 V	415 V	660 V	690 V					
	I _N (A)									
30	55,1	53,5	52,7	31,7	31,0	2960 ÷ 2970	≤ 1000	-15 / 40	No	
37	67,7	65,6	64,7	39,0	38,0	2960 ÷ 2970				
45	80,1	77,6	74,6	46,1	45,0	2965 ÷ 2970				
55	97,6	93,5	91,0	56,2	54,2	2960 ÷ 2965				

** Operating conditions to be referred to motor only. About electric pump, refer to limits in user's manual.

sv-IE3-mott55-2p50-en_a_te

Note: Observe the regulations and codes locally in force regarding sorted waste disposal.

SOUND EMISSION LEVELS

50 Hz 2900 min ⁻¹		LpA (dB \pm 2)**		
P2 (kW)	IEC*	GHV20	GHV30	GHV40
1,1	80	< 70	< 70	< 70
1,5	90	< 70	< 70	< 70
2,2	90	< 70	< 70	< 70
3	100R	< 70	< 70	< 70
4	112R	< 70	< 70	< 70
5,5	132R	< 70	< 70	< 70
7,5	132	74	76	77
11	160R	76	78	79
15	160	74	76	77
18,5	160	76	78	79
22	180R	73	75	76
30	200	75	77	78
37	200	75	77	78

* R=Reduced motor casing size with respect to shaft extension and related flange.

GHVcom_2p-en_a_tr

** Noise value of the electric motor only.

GVF.../SV BOOSTER SETS SERIES WORKING LIMITS

GVF.../SV

Liquids handled	Water containing no gas or corrosive and/or aggressive substances.
Fluid temperature	Above -10°C a + 80 °C
Ambient temperature	Above 0°C a + 40 °C
Maximum operating pressure	Max 8 bar, 10 bar, 16 bar in function of pump type
Minimum inlet pressure	According to NPSH curve and losses, with a minimum margin of 0.5 m
Maximum inlet pressure	The inlet pressure added to the pressure of the pump at zero flow must be lower than the maximum operating pressure of the set.
Installation	Indoors, protected from the weather. Away from heat sources. Max elevation 1000 m ASL. Max humidity 50% without condensation.
Hourly starts (single pump)	0,37 kW ≤ Pn ≤ 3 kW max 60 starts per hour. Direct motor start; 4 kW ≤ Pn ≤ kW max 40 starts per hour. Direct motor start; 11 kW ≤ Pn ≤ kW max 30 starts per hour. Direct motor start; 18,5 kW ≤ Pn ≤ 22 kW max 24 starts per hour. Direct motor start; 30 kW ≤ Pn ≤ 37 kW max 16 starts per hour. Start/delta start; Pn = 45 kW max 8 starts per hour. Start/delta start;
Sound emission	See table

* On request, PN above in function of the pump

gfix_2p-en_c_ti

GVF.../SV BOOSTER SETS SERIES MAIN COMPONENTS

- **Main on-off valves** at the suction and delivery of each pump; ball type up to 2" included.
For higher diameters, butterfly valves to be installed between the flanges.
- **Non return valve** on the delivery of each pump; spring type up to 2" included, double head type for larger sizes.
- **Suction manifold** with threaded or flanged ends, depending on set type (see drawings).
Threaded fitting for water loading.
- **Delivery manifold** with threaded or flanged ends, depending on set type (see drawings).
It has R1" threaded fittings with corresponding caps, for connection with diaphragm expansion vessels (hydro tube).
- **Pressure gauge and transmitters** for control, installed on the delivery manifold of the set.
- **Control** panel.
- **Various fittings** for the connections.
- **Support base** for the pump set and control panel bracket.
- **Anti-vibration feet** sized depending on the set.
For some sets, the assembling is the responsibility of the customer.

Versions available

Manifolds, valves, flanges, base and main components made of AISI 304 or AISI 316 stainless steel; versions GVF.../A304, GVF.../B304, GVF.../C304, GVF.../A316, GVF.../B316, GVF.../C316
Available in the Z version.

Accessories on request:

- Devices **for protection against dry running** in one of the following versions:
 - float switch
 - pack of electronic module and probe electrodes
 - minimum pressure switch
- **Diaphragm expansion vessel kit**
Hydrotube with on-off valve, depending on the maximum head of the pump:
 - 24 lt, 8 bar hydro tube kit
 - 24 lt, 10 bar hydro tube kit
 - 24 lt, 16 bar hydro tube kit
 - 20 lt, 25 bar hydro tube kit

SPECIAL EQUIPMENT ON REQUEST (Contact the Sales and Technical Assistance Service)

- Sets with stainless steel expansion vessels.
- Sets with special valves.
- Sets with 5 to 8 electric pumps.
- Sets with jockey pump.

GVF series booster sets with e-SV are certified for use with drinking water according to WRAS and ACS standards, and with Italian Ministry Decree no. 174.

GVF.../SV BOOSTER SETS SERIES
MATERIAL TABLE FOR SETS PUMPS, 3-5-10-15-22SV

GVF.../SV

DENOMINATION	G... (STANDARD)	G.../A304	G.../A316
Manifolds	AISI 304	AISI 304	AISI 316
On-off valves	Nickel-plated brass	AISI 316	AISI 316
Non-return valves	Brass	AISI 304	AISI 316
Pressure switches	Galvanized steel/AISI 301	AISI 301	AISI 301
Pressure transmitters	AISI 304	AISI 304	AISI 304
Caps/plugs/flanges	AISI 304 / 316	AISI 304 / 316	AISI 316
Fittings	AISI 316	AISI 316	AISI 316
Bracket	Galvanized steel/painted steel	Galvanized steel/painted steel	Galvanized steel/painted steel
Base	Painted steel	Painted steel	Painted steel

g_wad_3-22sv-en_a_tm

MATERIAL TABLE FOR SETS WITH PUMPS, 33-46-66-92-125SV

DENOMINATION	G... (STANDARD)	G.../A304	G.../A316
Manifolds	AISI 304	AISI 304	AISI 316
On-off valves	Epoxy	AISI 316	AISI 316
Non-return valves	Painted cast iron with stainless steel flaps	AISI 304	AISI 316
Pressure switches	Galvanized steel/AISI 301	AISI 301	AISI 301
Pressure transmitters	AISI 316	AISI 316	AISI 316
Caps/plugs/flanges	AISI 304 / 316	AISI 316	AISI 316
Fittings	AISI 316	AISI 316	AISI 316
Bracket	Painted steel	Painted steel	Painted steel
Base	Painted steel	Painted steel	Painted steel

g_wad_33-125sv-en_c_tm

GVF11/15SV SERIES BOOSTER SETS HYDRAULIC PERFORMANCE TABLE

PUMP TYPE	RATED POWER	MEI ≥	Q = DELIVERY													
			l/min 0	166,7	200	266	340	366,7	466	540	660	700	800	860	920	966,7
			m ³ /h 0	10,0	12,0	16,0	20,4	22,0	28,0	32,4	39,6	42,0	48,0	51,6	55,2	58,0
15SV06	2 x 5,5	0,70	87,6			81,5	79,4	78,4	74,1	69,9	60,3	56,3	44,2			
15SV07	2 x 5,5	0,70	101,9			94,5	91,9	90,8	85,7	80,6	69,4	64,7	50,5			
15SV08	2 x 7,5	0,70	117,4			110,9	108,0	106,8	100,8	94,9	82,0	76,7	60,6			
15SV09	2 x 7,5	0,70	131,9			124,4	121,0	119,6	112,8	106,1	91,5	85,5	67,4			
15SV10	2 x 11	0,70	147,7			138,8	135,3	133,8	126,7	119,6	103,9	97,4	77,5			

Hydraulic performances in compliance with ISO 9906:2012 - Grade 3B (ex ISO 9906:1999 - Annex A)

2p_gv_15sv-2p50-en_a_th

(1) Value referred to the F, T, R, N, V, C, K versions. P version excluded.

The table refers to performance with 2 pumps running.

GVF.../SV

GVF11/22SV SERIES BOOSTER SETS

PUMP TYPE	RATED POWER	MEI ≥	Q = DELIVERY													
			l/min 0	166,7	200	266	340	366,7	466	540	660	700	800	860	920	966,7
			m ³ /h 0	10,0	12,0	16,0	20,4	22,0	28,0	32,4	39,6	42,0	48,0	51,6	55,2	58,0
			H = TOTAL HEAD IN METRES OF COLUMN OF WATER													
22SV05	2 x 5,5	0,70	76,0					70,9	67,9	64,9	58,3	55,6	47,4	41,4	34,7	28,8
22SV06	2 x 7,5	0,70	93,2					88,8	85,7	82,5	75,4	72,4	63,3	56,7	49,1	42,6
22SV07	2 x 7,5	0,70	108,5					103,1	99,4	95,7	87,2	83,7	73,1	65,3	56,5	48,8
22SV08	2 x 11	0,70	124,6					119,2	115,2	111,0	101,6	97,7	85,7	77,0	66,9	58,2
22SV09	2 x 11	0,70	140,1					133,7	129,2	124,4	113,8	109,3	95,8	86,0	74,6	64,8
22SV10	2 x 11	0,70	155,4					148,2	143,1	137,8	125,9	120,9	105,8	94,8	82,3	71,3

Hydraulic performances in compliance with ISO 9906:2012 - Grade 3B (ex ISO 9906:1999 - Annex A)

2p_gv_22sv-2p50-en_a_th

(1) Value referred to the F, T, R, N, V, C, K versions. P version excluded.

The table refers to performance with 2 pumps running.

GVF11/33SV SERIES BOOSTER SETS

PUMP TYPE	RATED POWER	MEI ≥	Q = DELIVERY											
			l/min 0	500	600	733	833	1000	1167	1333	1500	1800	2000	
			m ³ /h 0	30	36	44	50	60	70	80	90	108	120	
			H = TOTAL HEAD METRES COLUMN OF WATER											
33SV1/1A	2 x 2,2	0,70	17,4	16,2	15,7	15	14	12,2	9,8	6,7				
33SV1	2 x 3	0,70	23,8	21,7	21,2	20	20	17,8	15,5	12,7				
33SV2/2A	2 x 4	0,70	35,1	34,1	33,3	32	30	27	22,4	16,6				
33SV2/1A	2 x 4	0,70	40,8	38,8	37,9	36	35	32	27,5	22,3				
33SV2	2 x 5,5	0,70	47,8	45	44,1	43	41	39	35	29,9				
33SV3/2A	2 x 5,5	0,70	57,7	55,2	53,8	51	49	44	38	29,6				
33SV3/1A	2 x 7,5	0,70	64,5	61,3	60	58	56	51	45	37				
33SV3	2 x 7,5	0,70	71,5	67,4	66,0	64	62	58	52,0	44,6				
33SV4/2A	2 x 7,5	0,70	82	78,8	77	74	72	66	58	47,2				
33SV4/1A	2 x 11	0,70	88,9	85	83	81	78	73	65	55,1				
33SV4	2 x 11	0,70	95,9	91,1	90	87	85	80	73	63,1				
33SV5/2A	2 x 11	0,70	106	101,6	100	96	93	85	76	63				
33SV5/1A	2 x 11	0,70	112,7	107,2	105	102	99	92	82	70				
33SV5	2 x 15	0,70	120,4	114,9	113	110	107	101	92	80,5				
33SV6/2A	2 x 15	0,70	131,2	126,9	125	120	116	108	96	81,2				
33SV6/1A	2 x 15	0,70	139,1	133,5	131	128	124	116	105	90,4				
33SV6	2 x 15	0,70	145,6	139	137	133	129	121	110	96,1				
33SV7/2A	2 x 15	0,70	156	149,9	147	143	138	128	115	98,2				

Hydraulic performances in compliance with ISO 9906:2012 - Grade 3B (ex ISO 9906:1999 - Annex A)

2p_33sv-2p50-en_a_th

The table refers to performance with 2 pumps running.

(1) Value referred to the G and N versions with PN ≤ 16 bar (1600 kPa). P version is excluded.

GVF11/46SV SERIES BOOSTER SETS HYDRAULIC PERFORMANCE TABLE

GVF.../SV

PUMP TYPE	RATED POWER kW	MEI ≥ (1)	Q = DELIVERY											
			l/min 0	500	600	733	833	1000	1167	1333	1500	1800	2000	
			m ³ /h 0	30	36	44	50	60	70	80	90	108	120	
H = TOTAL HEAD METRES COLUMN OF WATER														
46SV1/1A	2 x 3	0,70	19,5			19	18,8	17,9	16,7	15,1	13,1	8,5	4,6	
46SV1	2 x 4	0,70	27,2			24,0	23,5	22,5	21,4	19,9	18,2	14,3	10,8	
46SV2/2A	2 x 5,5	0,70	38,8			39,8	39,2	37,8	35,7	32,9	29,4	21,1	13,9	
46SV2	2 x 7,5	0,70	52,6			48,5	48	46	44	42	39	31,4	25,1	
46SV3/2A	2 x 11	0,70	64,7			65,1	64	62	60	56	52	40	30,8	
46SV3	2 x 11	0,70	80,8			74,3	73	71	68	65	60	50	40,7	
46SV4/2A	2 x 15	0,70	92,4			90,7	90	87	83	79	73	58	45,6	
46SV4	2 x 15	0,70	107,3			99,8	98	96	92	87	82	68	55,9	
46SV5/2A	2 x 18,5	0,70	117,2			114,8	113	110	106	100	93	75	60,2	
46SV5	2 x 18,5	0,70	134,5			125,1	123	120	116	110	103	86	71,5	
46SV6/2A	2 x 22	0,70	144			139,3	138	134	129	122	113	92	73	
46SV6	2 x 22	0,70	161			149,9	148	144	139	132	124	104	86	

Hydraulic performances in compliance with ISO 9906:2012 - Grade 3B (ex ISO 9906:1999 - Annex A)

2p_46sv-2p50-en_a_th

The table refers to performance with 2 pumps running.

(1) Value referred to the G and N versions with PN ≤ 16 bar (1600 kPa). P version is excluded.

GVF11/66SV SERIES BOOSTER SETS

PUMP TYPE	RATED POWER kW	MEI ≥ (1)	Q = DELIVERY												
			l/min 0	1000	1200	1400	1500	1800	2000	2400	2600	2833	3200	3600	4000
			m ³ /h 0	60	72	84	90	108	120	144	156	170	192	216	240
H = TOTAL HEAD METRES COLUMN OF WATER															
66SV1/1A	2 x 4	0,70	23,8	21,4	20,7	19,9	19,4	17,8	16,6	13,3	11,2	8,3			
66SV1	2 x 5,5	0,70	29,2	25,8	24,8	23,8	23,3	21,8	20,7	17,9	16,1	13,5			
66SV2/2A	2 x 7,5	0,70	47,5	42,6	41,2	39,5	38,6	36	32,9	26,4	22,2	16,4			
66SV2/1A	2 x 11	0,70	54,2	49,6	48,2	46,7	45,8	42,9	40,6	34,8	31,2	26,2			
66SV2	2 x 11	0,70	60,4	55,7	54,4	52,8	52	49,3	47,1	42	38,9	34,7			
66SV3/2A	2 x 15	0,70	78,4	71,6	70	67	66	62	58	49	43,3	35,3			
66SV3/1A	2 x 15	0,70	84,7	77,8	76	74	72	68	65	56	51	44,0			
66SV3	2 x 18,5	0,70	91,4	84,7	83	81	79	75	72	64	60	53,5			
66SV4/2A	2 x 18,5	0,70	108,9	99,6	97	94	92	86	82	70	63	52,8			
66SV4/1A	2 x 22	0,70	115,2	105,9	103	100	99	93	89	78	71	61,8			
66SV4	2 x 22	0,70	121,6	112,5	109,8	106,9	105,3	99,8	95,7	85,5	79,2	70,8			
66SV5/2A	2 x 30	0,70	139,1	127,5	124,1	120,2	118,2	111,1	105,5	91,5	82,7	70,4			
66SV5/1A	2 x 30	0,70	145,6	134,0	130,5	126,8	124,7	117,8	112,4	99,2	90,9	79,5			
66SV5	2 x 30	0,70	152,0	140,4	137,0	133,3	131,3	124,6	119,4	106,8	99,1	88,5			

Hydraulic performances in compliance with ISO 9906:2012 - Grade 3B (ex ISO 9906:1999 - Annex A)

2p_gv_66sv-220-2p50-en_a_th

(1) Value referred to the G, N versions. P version excluded.

The table refers to performance with 2 pumps running.

GVF11/92SV SERIES BOOSTER SETS

PUMP TYPE	RATED POWER kW	MEI ≥ (1)	Q = DELIVERY												
			l/min 0	1000	1200	1400	1500	1800	2000	2400	2600	2833	3200	3600	4000
			m ³ /h 0	60	72	84	90	108	120	144	156	170	192	216	240
H = TOTAL HEAD METRES COLUMN OF WATER															
92SV1/1A	2 x 5,5	0,60	24,5				22,2	21,5	20,9	19,4	18,5	17,3	15,0	11,8	7,9
92SV1	2 x 7,5	0,60	33,5				28,7	27,2	26,2	24,3	23,3	22,2	20,2	17,6	14,3
92SV2/2A	2 x 11	0,60	49,4				45,1	44	42,5	39,6	37,9	35,5	30,9	24,6	16,8
92SV2	2 x 15	0,60	67,8				58,2	55,3	53,4	49,5	47,6	45,2	41,4	36,3	29,6
92SV3/2A	2 x 18,5	0,60	82,4				74	71,6	69,6	65	62,1	58,6	52,2	43,6	32,9
92SV3	2 x 22	0,60	102,2				88	84	81	76	72,6	69,2	63,4	55,9	46,3
92SV4/2A	2 x 30	0,60	115,7				104,0	99,9	97,0	90,4	86,8	82,1	73,8	62,8	49,0
92SV4	2 x 30	0,60	133,1				117,0	111,7	108,0	100,6	96,8	92,3	84,6	74,8	62,5
92SV5	2 x 37	0,60	149,0				133,2	127,8	124,0	115,6	111,0	105,2	94,9	81,4	64,6

Hydraulic performances in compliance with ISO 9906:2012 - Grade 3B (ex ISO 9906:1999 - Annex A)

2p_gv_92sv-220-2p50-en_a_th

(1) Value referred to the G, N versions. P version excluded.

The table refers to performance with 2 pumps running.

GV11/125SV SERIES BOOSTER SETS HYDRAULIC PERFORMANCE TABLE

PUMP TYPE	RATED POWER kW	MEI ≥	Q = DELIVERY											
			l/min 0	1500	1800	2000	2400	2832	3400	3800	4000	4300	4600	5332
			m ³ /h 0	90	108	120	144	170	204	228	240	258	276	320
H = TOTAL HEAD IN METRES OF COLUMN OF WATER														
125SV1	2 x 7,5	-	27,6			20,8	19,8	18,6	16,8	15,3	14,4	12,9	11,3	6,2
125SV2	2 x 15	-	53,8			44,4	42,5	40,4	37,1	34,4	32,9	30,4	27,7	19,6
125SV3	2 x 22	-	80,7			66,5	63,8	60,6	55,7	51,6	49,4	45,7	41,5	29,4
125SV4	2 x 30	-	107,6			88,7	85,0	80,7	74,2	68,8	65,8	60,9	55,4	39,2
125SV5	2 x 37	-	134,5			110,9	106,3	100,9	92,8	86,0	82,3	76,1	69,2	49,0

Hydraulic performances in compliance with ISO 9906:2012 - Grade 3B (ex ISO 9906:1999 - Annex A)

2p_gv_125sv-220-2p50-en_b_th

(1) Value referred to the G, N versions. P version excluded.

The table refers to performance with 2 pumps running.

GVF12/15SV SERIES BOOSTER SETS HYDRAULIC PERFORMANCE TABLE

GVF.../SV

PUMP TYPE	RATED POWER kW	MEI ≥ (1)	Q = DELIVERY													
			l/min 0	250	300	399	510	550	699	810	990	1050	1200	1290	1380	1450
			m ³ /h 0	15,0	18,0	23,9	30,6	33,0	41,9	48,6	59,4	63,0	72,0	77,4	82,8	87,0
H = TOTAL HEAD IN METRES OF COLUMN OF WATER																
15SV02	3 x 2,2	0,70	28,7			26,7	25,9	25,5	23,9	22,4	18,9	17,4	13,1			
15SV03	3 x 3	0,70	43,3			40,4	39,1	38,6	36,2	33,8	28,7	26,5	20,1			
15SV04	3 x 4	0,70	58,4			54,7	53,1	52,5	49,4	46,3	39,7	36,9	28,7			
15SV05	3 x 4	0,70	72,7			67,8	65,8	65,0	61,0	57,1	48,7	45,2	34,9			
15SV06	3 x 5,5	0,70	87,6			81,5	79,4	78,4	74,1	69,9	60,3	56,3	44,2			
15SV07	3 x 5,5	0,70	101,9			94,5	91,9	90,8	85,7	80,6	69,4	64,7	50,5			
15SV08	3 x 7,5	0,70	117,4			110,9	108,0	106,8	100,8	94,9	82,0	76,7	60,6			
15SV09	3 x 7,5	0,70	131,9			124,4	121,0	119,6	112,8	106,1	91,5	85,5	67,4			
15SV10	3 x 11	0,70	147,7			138,8	135,3	133,8	126,7	119,6	103,9	97,4	77,5			

Hydraulic performances in compliance with ISO 9906:2012 - Grade 3B (ex ISO 9906:1999 - Annex A)

3p_gv_15sv-2p50-en_a_th

(1) Value referred to the F, T, R, N, V, C, K versions. P version excluded.

The table refers to performance with 3 pumps running.

GVF12/22SV SERIES BOOSTER SETS

PUMP TYPE	RATED POWER kW	MEI ≥ (1)	Q = DELIVERY														
			l/min 0	83,34	100	133	170	183,3	233	270	330	350	400	430	460	483,3	
			m ³ /h 0	5,0	6,0	8,0	10,2	11,0	14,0	16,2	19,8	21,0	24,0	25,8	27,6	29,0	
H = TOTAL HEAD IN METRES OF COLUMN OF WATER																	
22SV02	3 x 2,2	0,70	30,4						28,4	27,2	26,0	23,3	22,2	18,9	16,6	13,8	11,5
22SV03	3 x 3	0,70	45,4						42,2	40,4	38,5	34,5	32,8	27,8	24,2	20,2	16,6
22SV04	3 x 4	0,70	60,9						56,8	54,4	51,9	46,6	44,4	37,9	33,1	27,7	23,0
22SV05	3 x 5,5	0,70	76,0						70,9	67,9	64,9	58,3	55,6	47,4	41,4	34,7	28,8
22SV06	3 x 7,5	0,70	93,2						88,8	85,7	82,5	75,4	72,4	63,3	56,7	49,1	42,6
22SV07	3 x 7,5	0,70	108,5						103,1	99,4	95,7	87,2	83,7	73,1	65,3	56,5	48,8
22SV08	3 x 11	0,70	124,6						119,2	115,2	111,0	101,6	97,7	85,7	77,0	66,9	58,2
22SV09	3 x 11	0,70	140,1						133,7	129,2	124,4	113,8	109,3	95,8	86,0	74,6	64,8
22SV10	3 x 11	0,70	155,4						148,2	143,1	137,8	125,9	120,9	105,8	94,8	82,3	71,3

Hydraulic performances in compliance with ISO 9906:2012 - Grade 3B (ex ISO 9906:1999 - Annex A)

3p_gv_22sv-2p50-en_a_th

(1) Value referred to the F, T, R, N, V, C, K versions. P version excluded.

The table refers to performance with 3 pumps running.

GVF12/33SV SERIES BOOSTER SETS

PUMP TYPE	RATED POWER kW	MEI ≥ (1)	Q = DELIVERY													
			l/min 0	750	900	1100	1250	1500	1750	2000	2250	2700	3000			
			m ³ /h 0	45	54	66	75	90	105	120	135	162	180			
H = TOTAL HEAD METRES COLUMN OF WATER																
33SV1/1A	3 x 2,2	0,70	17,4	16,2	15,7	15	14	12,2	9,8	6,7						
33SV1	3 x 3	0,70	23,8	21,7	21,2	20	20	17,8	15,5	12,7						
33SV2/2A	3 x 4	0,70	35,1	34,1	33,3	32	30	27	22,4	16,6						
33SV2/1A	3 x 4	0,70	40,8	38,8	37,9	36	35	32	27,5	22,3						
33SV2	3 x 5,5	0,70	47,8	45	44,1	43	41	39	35	29,9						
33SV3/2A	3 x 5,5	0,70	57,7	55,2	53,8	51	49	44	38	29,6						
33SV3/1A	3 x 7,5	0,70	64,5	61,3	60	58	56	51	45	37						
33SV3	3 x 7,5	0,70	71,5	67,4	66,0	64	62	58	52,0	44,6						
33SV4/2A	3 x 7,5	0,70	82	78,8	77	74	72	66	58	47,2						
33SV4/1A	3 x 11	0,70	88,9	85	83	81	78	73	65	55,1						
33SV4	3 x 11	0,70	95,9	91,1	90	87	85	80	73	63,1						
33SV5/2A	3 x 11	0,70	106	101,6	100	96	93	85	76	63						
33SV5/1A	3 x 11	0,70	112,7	107,2	105	102	99	92	82	70						
33SV5	3 x 15	0,70	120,4	114,9	113	110	107	101	92	80,5						
33SV6/2A	3 x 15	0,70	131,2	126,9	125	120	116	108	96	81,2						
33SV6/1A	3 x 15	0,70	139,1	133,5	131	128	124	116	105	90,4						
33SV6	3 x 15	0,70	145,6	139	137	133	129	121	110	96,1						
33SV7/2A	3 x 15	0,70	156	149,9	147	143	138	128	115	98,2						

Hydraulic performances in compliance with ISO 9906:2012 - Grade 3B (ex ISO 9906:1999 - Annex A)

3p_33sv-2p50-en_a_th

(1) Value referred to the G and N versions with PN ≤ 16 bar (1600 kPa). P version is excluded.

The table refers to performance with 3 pumps running.

GVF12/46SV SERIES BOOSTER SETS HYDRAULIC PERFORMANCE TABLE

PUMP TYPE	RATED POWER kW	MEI ≥ (1)	Q = DELIVERY										
			l/min 0	750	900	1100	1250	1500	1750	2000	2250	2700	3000
			m ³ /h 0	45	54	66	75	90	105	120	135	162	180
H = TOTAL HEAD METRES COLUMN OF WATER													
46SV1/1A	3 x 3	0,70	19,5			19	18,8	17,9	16,7	15,1	13,1	8,5	4,6
46SV1	3 x 4	0,70	27,2			24,0	23,5	22,5	21,4	19,9	18,2	14,3	10,8
46SV2/2A	3 x 5,5	0,70	38,8			39,8	39,2	37,8	35,7	32,9	29,4	21,1	13,9
46SV2	3 x 7,5	0,70	52,6			48,5	48	46	44	42	39	31,4	25,1
46SV3/2A	3 x 11	0,70	64,7			65,1	64	62	60	56	52	40	30,8
46SV3	3 x 11	0,70	80,8			74,3	73	71	68	65	60	50	40,7
46SV4/2A	3 x 15	0,70	92,4			90,7	90	87	83	79	73	58	45,6
46SV4	3 x 15	0,70	107,3			99,8	98	96	92	87	82	68	55,9
46SV5/2A	3 x 18,5	0,70	117,2			114,8	113	110	106	100	93	75	60,2
46SV5	3 x 18,5	0,70	134,5			125,1	123	120	116	110	103	86	71,5
46SV6/2A	3 x 22	0,70	144			139,3	138	134	129	122	113	92	73
46SV6	3 x 22	0,70	161			149,9	148	144	139	132	124	104	86

Hydraulic performances in compliance with ISO 9906:2012 - Grade 3B (ex ISO 9906:1999 - Annex A)

3p_46sv-2p50-en_a_th

(1) Value referred to the G and N versions with PN ≤ 16 bar (1600 kPa). P version is excluded.

The table refers to performance with 3 pumps running.

GVF12/66SV SERIES BOOSTER SETS

PUMP TYPE	RATED POWER kW	MEI ≥ (1)	Q = DELIVERY												
			l/min 0	1500	1800	2100	2250	2700	3000	3600	3900	4250	4800	5400	6000
			m ³ /h 0	90	108	126	135	162	180	216	234	255	288	324	360
H = TOTAL HEAD METRES COLUMN OF WATER															
66SV1/1A	3 x 4	0,70	23,8	21,4	20,7	19,9	19,4	17,8	16,6	13,3	11,2	8,3			
66SV1	3 x 5,5	0,70	29,2	25,8	24,8	23,8	23,3	21,8	20,7	17,9	16,1	13,5			
66SV2/2A	3 x 7,5	0,70	47,5	42,6	41,2	39,5	38,6	36	32,9	26,4	22,2	16,4			
66SV2/1A	3 x 11	0,70	54,2	49,6	48,2	46,7	45,8	42,9	40,6	34,8	31,2	26,2			
66SV2	3 x 11	0,70	60,4	55,7	54,4	52,8	52	49,3	47,1	42	38,9	34,7			
66SV3/2A	3 x 15	0,70	78,4	71,6	70	67	66	62	58	49	43,3	35,3			
66SV3/1A	3 x 15	0,70	84,7	77,8	76	74	72	68	65	56	51	44,0			
66SV3	3 x 18,5	0,70	91,4	84,7	83	81	79	75	72	64	60	53,5			
66SV4/2A	3 x 18,5	0,70	108,9	99,6	97	94	92	86	82	70	63	52,8			
66SV4/1A	3 x 22	0,70	115,2	105,9	103	100	99	93	89	78	71	61,8			
66SV4	3 x 22	0,70	121,6	112,5	110	107	105	100	96	86	79	70,8			
66SV5/2A	3 x 30	0,70	139,1	127,5	124	120	118	111	106	92	83	70,4			
66SV5/1A	3 x 30	0,70	145,6	134	131	127	125	118	112	99	91	79,5			
66SV5	3 x 30	0,70	152	140,4	137	133	131	125	119	107	99	88,5			

Hydraulic performances in compliance with ISO 9906:2012 - Grade 3B (ex ISO 9906:1999 - Annex A)

3p_66sv-2p50-en_a_th

(1) Value referred to the G, N versions. P version excluded.

The table refers to performance with 3 pumps running.

GVF12/92SV SERIES BOOSTER SETS

PUMP TYPE	RATED POWER kW	MEI ≥ (1)	Q = DELIVERY												
			l/min 0	1500	1800	2100	2250	2700	3000	3600	3900	4250	4800	5400	6000
			m ³ /h 0	90	108	126	135	162	180	216	234	255	288	324	360
H = TOTAL HEAD METRES COLUMN OF WATER															
92SV1/1A	3 x 5,5	0,60	24,5				22,2	21,5	20,9	19,4	18,5	17,3	15,0	11,8	7,9
92SV1	3 x 7,5	0,60	33,5				28,7	27,2	26,2	24,3	23,3	22,2	20,2	17,6	14,3
92SV2/2A	3 x 11	0,60	49,4				45,1	44	42,5	39,6	37,9	35,5	30,9	24,6	16,8
92SV2	3 x 15	0,60	67,8				58,2	55,3	53,4	49,5	47,6	45,2	41,4	36,3	29,6
92SV3/2A	3 x 18,5	0,60	82,4				74	71,6	69,6	65	62,1	58,6	52,2	43,6	32,9
92SV3	3 x 22	0,60	102,2				88	84	81	76	72,6	69,2	63,4	55,9	46,3
92SV4/2A	3 x 30	0,60	115,7				104	100	97	90	87	82,1	73,8	62,8	49,0
92SV4	3 x 30	0,60	133,1				117	112	108	101	97	92,3	84,6	74,8	62,5
92SV5/2A	3 x 37	0,60	149,0				133	128	124	116	111	105,2	94,9	81,4	64,6

Hydraulic performances in compliance with ISO 9906:2012 - Grade 3B (ex ISO 9906:1999 - Annex A)

3p_92sv-2p50-en_a_th

(1) Value referred to the G, N versions. P version excluded.

The table refers to performance with 3 pumps running.

GVF12/125SV SERIES BOOSTER SETS HYDRAULIC PERFORMANCE TABLE

PUMP TYPE	RATED POWER kW	MEI ≥	Q = DELIVERY											
			l/min 0	2250	2700	3000	3600	4248	5100	5700	6000	6450	6900	2666
			m ³ /h 0	135	162	180	216	255	306	342	360	387	414	480
H = TOTAL HEAD IN METRES OF COLUMN OF WATER														
125SV1	3 x 7,5	-	27,6			20,8	19,8	18,6	16,8	15,3	14,4	12,9	11,3	6,2
125SV2	3 x 15	-	53,8			44,4	42,5	40,4	37,1	34,4	32,9	30,4	27,7	19,6
125SV3	3 x 22	-	80,7			66,5	63,8	60,6	55,7	51,6	49,4	45,7	41,5	29,4
125SV4	3 x 30	-	107,6			88,7	85,0	80,7	74,2	68,8	65,8	60,9	55,4	39,2
125SV5	3 x 37	-	134,5			110,9	106,3	100,9	92,8	86,0	82,3	76,1	69,2	49,0

Hydraulic performances in compliance with ISO 9906:2012 - Grade 3B (ex ISO 9906:1999 - Annex A)

3p_125sv-2p50-en_a_th

(1) Value referred to the G, N versions. P version excluded.

The table refers to performance with 3 pumps running.

GVF.../SV

GVF13/15SV SERIES BOOSTER SETS HYDRAULIC PERFORMANCE TABLE

PUMP TYPE	RATED POWER kW	MEI ≥ (1)	Q = DELIVERY													
			l/min 0	333,4	400	532	680	733,4	932	1080	1320	1400	1600	1720	1840	1933
			m ³ /h 0	20,0	24,0	31,9	40,8	44,0	55,9	64,8	79,2	84,0	96,0	103,2	110,4	116,0
H = TOTAL HEAD IN METRES OF COLUMN OF WATER																
15SV02	4 x 2,2	0,70	28,7			26,7	25,9	25,5	23,9	22,4	18,9	17,4	13,1			
15SV03	4 x 3	0,70	43,3			40,4	39,1	38,6	36,2	33,8	28,7	26,5	20,1			
15SV04	4 x 4	0,70	58,4			54,7	53,1	52,5	49,4	46,3	39,7	36,9	28,7			
15SV05	4 x 4	0,70	72,7			67,8	65,8	65,0	61,0	57,1	48,7	45,2	34,9			
15SV06	4 x 5,5	0,70	87,6			81,5	79,4	78,4	74,1	69,9	60,3	56,3	44,2			
15SV07	4 x 5,5	0,70	101,9			94,5	91,9	90,8	85,7	80,6	69,4	64,7	50,5			
15SV08	4 x 7,5	0,70	117,4			110,9	108,0	106,8	100,8	94,9	82,0	76,7	60,6			
15SV09	4 x 7,5	0,70	131,9			124,4	121,0	119,6	112,8	106,1	91,5	85,5	67,4			
15SV10	4 x 11	0,70	147,7			138,8	135,3	133,8	126,7	119,6	103,9	97,4	77,5			

Hydraulic performances in compliance with ISO 9906:2012 - Grade 3B (ex ISO 9906:1999 - Annex A)

4p_gv_15sv-2p50-en_a_th

(1) Value referred to the F, T, R, N, V, C, K versions. P version excluded.

The table refers to performance with 4 pumps running.

GVF.../SV

GVF13/22SV SERIES BOOSTER SETS

PUMP TYPE	RATED POWER kW	MEI ≥ (1)	Q = DELIVERY													
			l/min 0	83,34	100	133	170	183,3	233	270	330	350	400	430	460	483,3
			m ³ /h 0	5,0	6,0	8,0	10,2	11,0	14,0	16,2	19,8	21,0	24,0	25,8	27,6	29,0
H = TOTAL HEAD IN METRES OF COLUMN OF WATER																
22SV02	4 x 2,2	0,70	30,4					28,4	27,2	26,0	23,3	22,2	18,9	16,6	13,8	11,5
22SV03	4 x 3	0,70	45,4					42,2	40,4	38,5	34,5	32,8	27,8	24,2	20,2	16,6
22SV04	4 x 4	0,70	60,9					56,8	54,4	51,9	46,6	44,4	37,9	33,1	27,7	23,0
22SV05	4 x 5,5	0,70	76,0					70,9	67,9	64,9	58,3	55,6	47,4	41,4	34,7	28,8
22SV06	4 x 7,5	0,70	93,2					88,8	85,7	82,5	75,4	72,4	63,3	56,7	49,1	42,6
22SV07	4 x 7,5	0,70	108,5					103,1	99,4	95,7	87,2	83,7	73,1	65,3	56,5	48,8
22SV08	4 x 11	0,70	124,6					119,2	115,2	111,0	101,6	97,7	85,7	77,0	66,9	58,2
22SV09	4 x 11	0,70	140,1					133,7	129,2	124,4	113,8	109,3	95,8	86,0	74,6	64,8
22SV10	4 x 11	0,70	155,4					148,2	143,1	137,8	125,9	120,9	105,8	94,8	82,3	71,3

Hydraulic performances in compliance with ISO 9906:2012 - Grade 3B (ex ISO 9906:1999 - Annex A)

4p_gv_22sv-2p50-en_a_th

(1) Value referred to the F, T, R, N, V, C, K versions. P version excluded.

The table refers to performance with 4 pumps running.

GVF13/33SV SERIES BOOSTER SETS

PUMP TYPE	RATED POWER kW	MEI ≥ (1)	Q = DELIVERY											
			l/min 0	1000	1200	1467	1667	2000	2333	2667	3000	3600	4000	
			m ³ /h 0	60	72	88	100	120	140	160	180	216	240	
H = TOTAL HEAD METRES COLUMN OF WATER														
33SV1/1A	4 x 2,2	0,70	17,4	16,2	15,7	15	14	12,2	9,8	6,7				
33SV1	4 x 3	0,70	23,8	21,7	21,2	20	20	17,8	15,5	12,7				
33SV2/2A	4 x 4	0,70	35,1	34,1	33,3	32	30	27	22,4	16,6				
33SV2/1A	4 x 4	0,70	40,8	38,8	37,9	36	35	32	27,5	22,3				
33SV2	4 x 5,5	0,70	47,8	45	44,1	43	41	39	35	29,9				
33SV3/2A	4 x 5,5	0,70	57,7	55,2	53,8	51	49	44	38	29,6				
33SV3/1A	4 x 7,5	0,70	64,5	61,3	60	58	56	51	45	37				
33SV3	4 x 7,5	0,70	71,5	67,4	66,0	64	62	58	52,0	44,6				
33SV4/2A	4 x 7,5	0,70	82	78,8	77	74	72	66	58	47,2				
33SV4/1A	4 x 11	0,70	88,9	85	83	81	78	73	65	55,1				
33SV4	4 x 11	0,70	95,9	91,1	90	87	85	80	73	63,1				
33SV5/2A	4 x 11	0,70	106	101,6	100	96	93	85	76	63				
33SV5/1A	4 x 11	0,70	112,7	107,2	105	102	99	92	82	70				
33SV5	4 x 15	0,70	120,4	114,9	113	110	107	101	92	80,5				
33SV6/2A	4 x 15	0,70	131,2	126,9	125	120	116	108	96	81,2				
33SV6/1A	4 x 15	0,70	139,1	133,5	131	128	124	116	105	90,4				
33SV6	4 x 15	0,70	145,6	139	137	133	129	121	110	96,1				
33SV7/2A	4 x 15	0,70	156	149,9	147	143	138	128	115	98,2				

Hydraulic performances in compliance with ISO 9906:2012 - Grade 3B (ex ISO 9906:1999 - Annex A)

4p_33sv-2p50-en_a_th

(1) Value referred to the G and N versions with PN ≤ 16 bar (1600 kPa). P version is excluded.

The table refers to performance with 4 pumps running.

GVF13/46SV SERIES BOOSTER SETS HYDRAULIC PERFORMANCE TABLE

GVF.../SV

PUMP TYPE	RATED POWER kW	MEI ≥ (1)	Q = DELIVERY										
			l/min 0 m ³ /h 0	1000 60	1200 72	1467 88	1667 100	2000 120	2333 140	2667 160	3000 180	3600 216	4000 240
H = TOTAL HEAD METRES COLUMN OF WATER													
46SV1/1A	4 x 3	0,70	19,5			19	18,8	17,9	16,7	15,1	13,1	8,5	4,6
46SV1	4 x 4	0,70	27,2			24,0	23,5	22,5	21,4	19,9	18,2	14,3	10,8
46SV2/2A	4 x 5,5	0,70	38,8			39,8	39,2	37,8	35,7	32,9	29,4	21,1	13,9
46SV2	4 x 7,5	0,70	52,6			48,5	48	46	44	42	39	31,4	25,1
46SV3/2A	4 x 11	0,70	64,7			65,1	64	62	60	56	52	40	30,8
46SV3	4 x 11	0,70	80,8			74,3	73	71	68	65	60	50	40,7
46SV4/2A	4 x 15	0,70	92,4			90,7	90	87	83	79	73	58	45,6
46SV4	4 x 15	0,70	107,3			99,8	98	96	92	87	82	68	55,9
46SV5/2A	4 x 18,5	0,70	117,2			114,8	113	110	106	100	93	75	60,2
46SV5	4 x 18,5	0,70	134,5			125,1	123	120	116	110	103	86	71,5
46SV6/2A	4 x 22	0,70	144			139,3	138	134	129	122	113	92	73
46SV6	4 x 22	0,70	161			149,9	148	144	139	132	124	104	86

Hydraulic performances in compliance with ISO 9906:2012 - Grade 3B (ex ISO 9906:1999 - Annex A)

4p_46sv-2p50-en_a_th

(1) Value referred to the G and N versions with PN ≤ 16 bar (1600 kPa). P version is excluded.

The table refers to performance with 4 pumps running.

GVF13/66SV SERIES BOOSTER SETS

PUMP TYPE	RATED POWER kW	MEI ≥ (1)	Q = DELIVERY											
			l/min 0 m ³ /h 0	2000 120	2400 144	2800 168	3000 180	3600 216	4000 240	4800 288	5200 312	5667 340	6400 384	7200 432
H = TOTAL HEAD METRES COLUMN OF WATER														
66SV1/1A	4 x 4	0,70	23,8	21,4	20,7	19,9	19,4	17,8	16,6	13,3	11,2	8,3		
66SV1	4 x 5,5	0,70	29,2	25,8	24,8	23,8	23,3	21,8	20,7	17,9	16,1	13,5		
66SV2/2A	4 x 7,5	0,70	47,5	42,6	41,2	39,5	38,6	36	32,9	26,4	22,2	16,4		
66SV2/1A	4 x 11	0,70	54,2	49,6	48,2	46,7	45,8	42,9	40,6	34,8	31,2	26,2		
66SV2	4 x 11	0,70	60,4	55,7	54,4	52,8	52	49,3	47,1	42	38,9	34,7		
66SV3/2A	4 x 15	0,70	78,4	71,6	70	67	66	62	58	49	43,3	35,3		
66SV3/1A	4 x 15	0,70	84,7	77,8	76	74	72	68	65	56	51	44,0		
66SV3	4 x 18,5	0,70	91,4	84,7	83	81	79	75	72	64	60	53,5		
66SV4/2A	4 x 18,5	0,70	108,9	99,6	97	94	92	86	82	70	63	52,8		
66SV4/1A	4 x 22	0,70	115,2	105,9	103	100	99	93	89	78	71	61,8		
66SV4	4 x 22	0,70	121,6	112,5	110	107	105	100	96	86	79	70,8		
66SV5/2A	4 x 30	0,70	139,1	127,5	124	120	118	111	106	92	83	70,4		
66SV5/1A	4 x 30	0,70	145,6	134	131	127	125	118	112	99	91	79,5		
66SV5	4 x 30	0,70	152	140,4	137	133	131	125	119	107	99	88,5		

Hydraulic performances in compliance with ISO 9906:2012 - Grade 3B (ex ISO 9906:1999 - Annex A)

4p_66sv-2p50-en_a_th

(1) Value referred to the G, N versions. P version excluded.

The table refers to performance with 4 pumps running.

GVF13/92SV SERIES BOOSTER SETS HYDRAULIC PERFORMANCE TABLE

PUMP TYPE	RATED POWER kW	MEI ≥ (1)	Q = DELIVERY												
			l/min 0	2000	2400	2800	3000	3600	4000	4800	5200	5667	6400	7200	8000
			m ³ /h 0	120	144	168	180	216	240	288	312	340	384	432	480
H = TOTAL HEAD METRES COLUMN OF WATER															
92SV1/1A	4 x 5,5	0,60	24,5				22,2	21,5	20,9	19,4	18,5	17,3	15,0	11,8	7,9
92SV1	4 x 7,5	0,60	33,5				28,7	27,2	26,2	24,3	23,3	22,2	20,2	17,6	14,3
92SV2/2A	4 x 11	0,60	49,4				45,1	44	42,5	39,6	37,9	35,5	30,9	24,6	16,8
92SV2	4 x 15	0,60	67,8				58,2	55,3	53,4	49,5	47,6	45,2	41,4	36,3	29,6
92SV3/2A	4 x 18,5	0,60	82,4				74	71,6	69,6	65	62,1	58,6	52,2	43,6	32,9
92SV3	4 x 22	0,60	102,2				88	84	81	76	72,6	69,2	63,4	55,9	46,3
92SV4/2A	4 x 30	0,60	115,7				104	100	97	90	87	82,1	73,8	62,8	49,0
92SV4	4 x 30	0,60	133,1				117	112	108	101	97	92,3	84,6	74,8	62,5
92SV5/2A	4 x 37	0,60	149,0				133	128	124	116	111	105,2	94,9	81,4	64,6

Hydraulic performances in compliance with ISO 9906:2012 - Grade 3B (ex ISO 9906:1999 - Annex A)

4p_92sv-2p50-en_a_th

(1) Value referred to the G, N versions. P version excluded.

The table refers to performance with 4 pumps running.

GVF13/125SV SERIES BOOSTER SETS

PUMP TYPE	RATED POWER kW	MEI ≥	Q = DELIVERY											
			l/min 0	3000	3600	4000	4800	5664	6800	7600	8000	8600	9200	2666
			m ³ /h 0	180	216	240	288	340	408	456	480	516	552	640
H = TOTAL HEAD IN METRES OF COLUMN OF WATER														
125SV1	4 x 7,5	-	27,6			20,8	19,8	18,6	16,8	15,3	14,4	12,9	11,3	6,2
125SV2	4 x 15	-	53,8			44,4	42,5	40,4	37,1	34,4	32,9	30,4	27,7	19,6
125SV3	4 x 22	-	80,7			66,5	63,8	60,6	55,7	51,6	49,4	45,7	41,5	29,4
125SV4	4 x 30	-	107,6			88,7	85,0	80,7	74,2	68,8	65,8	60,9	55,4	39,2
125SV5	4 x 37	-	134,5			110,9	106,3	100,9	92,8	86,0	82,3	76,1	69,2	49,0

Hydraulic performances in compliance with ISO 9906:2012 - Grade 3B (ex ISO 9906:1999 - Annex A)

4p_125sv-2p50-en_a_th

(1) Value referred to the G, N versions. P version excluded.

The table refers to performance with 4 pumps running.

GVF11, GVF12, GVF13/15-22-33SV SERIES BOOSTER SETS ELECTRICAL DATA TABLE

GVF.../SV

SERVICE PUMP 3 X 400 V			CURRENT ABSORBED BY SET 3 X 400V		
TYPE	Pn kW	In A	GV11 A	GV12 A	GV13 A
15SV02	2,2	4,64	-	14,9	19,6
15SV03	3	6,14	-	19,4	25,6
15SV04	4	7,63	-	23,9	31,5
15SV05	4	7,63	-	23,9	31,5
15SV06	5,5	10,40	21,8	32,2	42,6
15SV07	5,5	10,40	21,8	32,2	42,6
15SV08	7,5	14,00	29,0	43,0	57,0
15SV09	7,5	14,00	29,0	43,0	57,0
15SV10	11	20,30	41,6	61,9	82,2
22SV02	2,2	4,64	-	14,9	19,6
22SV03	3	6,14	-	19,4	25,6
22SV04	4	7,63	-	23,9	31,5
22SV05	5,5	10,40	21,8	32,2	42,6
22SV06	7,5	14,00	29,0	43,0	57,0
22SV07	7,5	14,00	29,0	43,0	57,0
22SV08	11	20,30	41,6	61,9	82,2
22SV09	11	20,30	41,6	61,9	82,2
22SV10	11	20,30	41,6	61,9	82,2
33SV1/1A	2,2	4,64	10,3	14,9	19,6
33SV1	3	6,14	13,3	19,4	25,6
33SV2/2A	4	7,63	16,3	23,9	31,5
33SV2/1A	4	7,63	16,3	23,9	31,5
33SV2	5,5	10,40	21,8	32,2	42,6
33SV3/2A	5,5	10,40	21,8	32,2	42,6
33SV3/1A	7,5	14,00	29,0	43,0	57,0
33SV3	7,5	14,00	29,0	43,0	57,0
33SV4/2A	7,5	14,00	29,0	43,0	57,0
33SV4/1A	11	20,30	41,6	61,9	82,2
33SV4	11	20,30	41,6	61,9	82,2
33SV5/2A	11	20,30	41,6	61,9	82,2
33SV5/1A	11	20,30	41,6	61,9	82,2
33SV5	15	26,00	53,0	79,0	105,0
33SV6/2A	15	26,00	53,0	79,0	105,0
33SV6/1A	15	26,00	53,0	79,0	105,0
33SV6	15	26,00	53,0	79,0	105,0
33SV7/2A	15	26,00	53,0	79,0	105,0

The current shown is the nominal current of the set.

gv_15-33sv_2p50-en_c_te

GVF11, GVF12, GVF13/46-66-92-125SV SERIES BOOSTER SETS ELECTRICAL DATA TABLE

SERVICE PUMP 3 X 400 V			CURRENT ABSORBED BY SET 3 X 400V		
TYPE	Pn kW	In A	GV11 A	GV12 A	GV13 A
46SV1/1A	3	6,14	13,3	19,4	25,6
46SV1	4	7,63	16,3	23,9	31,5
46SV2/2A	5,5	10,40	21,8	32,2	42,6
46SV2	7,5	14,00	29,0	43,0	57,0
46SV3/2A	11	20,30	41,6	61,9	82,2
46SV3	11	20,30	41,6	61,9	82,2
46SV4/2A	15	26,00	53,0	79,0	105,0
46SV4	15	26,00	53,0	79,0	105,0
46SV5/2A	18,5	33,20	67,4	100,6	133,8
46SV5	18,5	33,20	67,4	100,6	133,8
46SV6/2A	22	38,60	78,2	116,8	155,4
46SV6	22	38,60	78,2	116,8	155,4
66SV1/1A	4	7,63	16,3	23,9	31,6
66SV1	5,5	10,40	21,8	32,2	42,6
66SV2/2A	7,5	14,00	29,0	43,0	57,0
66SV2/1A	11	20,30	41,6	61,9	82,2
66SV2	11	20,30	41,6	61,9	82,2
66SV3/2A	15	26,00	53,0	79,0	105,0
66SV3/1A	15	26,00	53,0	79,0	105,0
66SV3	18,5	33,20	67,4	100,6	133,8
66SV4/2A	18,5	33,20	67,4	100,6	133,8
66SV4/1A	22	38,60	78,2	116,8	155,4
66SV4	22	38,60	78,2	116,8	155,4
66SV5/2A	30	53,60	108,2	161,8	215,4
66SV5/1A	30	53,60	108,2	161,8	215,4
66SV5	30	53,60	108,2	161,8	215,4
92SV1/1A	5,5	10,40	21,8	32,2	42,6
92SV1	7,5	14,00	29,0	43,0	57,0
92SV2/2A	11	20,30	41,6	61,9	82,2
92SV2	15	26,00	53,0	79,0	105,0
92SV3/2A	18,5	33,20	67,4	100,6	133,8
92SV3	22	38,60	78,2	116,8	155,4
92SV4/2A	30	53,60	108,2	161,8	215,4
92SV4	30	53,60	108,2	161,8	215,4
92SV5/2A	37	65,80	132,6	198,4	264,2
125SV1	7,5	14,00	29,0	43,0	57,0
125SV2	15	26,00	53,0	79,0	105,0
125SV3	22	38,60	78,2	116,8	155,4
125SV4	30	53,60	108,2	161,8	215,4
125SV5	37	65,80	132,6	198,4	264,2

The current shown is the nominal current of the set.

gv_46-125sv_2p50-en_b_te

GVF.../SV

Booster sets

MARKET SECTORS
RESIDENTIAL-CIVIL, INDUSTRIAL

APPLICATIONS

- Water network supply in housing complexes, offices, hotels, shopping centres, industrial plants.
- Supply of water networks for agricultural applications (e.g. irrigation).

GVF11...D GVF11...R Series

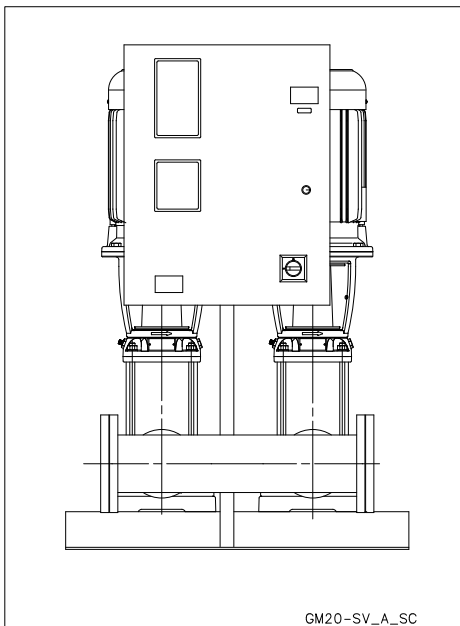

GVF11D
GVF11Y

SPECIFICATIONS

- **Flow rate:**
up to 320 m³/h.
- **Head:**
up to 160 m.
- **Electrical panel supply voltage:**
3 x 400V ± 10%.
- **Frequency:**
50 Hz.
- **Voltage for controls outside panel:**
24 Vac.
- **Electrical panel and electric pump protection class**
IP 55.
- **Maximum service pump power:**
2 x 37 kW.
- **Starting fixed-speed motors:**
 - Direct for powers up to 22 kW inclusive for pump (GVF...D).
 - Star/Delta on request (GVF...Y set).
 - Softstarter, for higher powers (GVF...R set).
- **Electric pumps with vertical axis:**
 - SV series (motor protection class IP55).
- **Maximum operating pressure:**
16 bar.
- **Maximum temperature of pumped liquid :**
+80°C.

GVF series booster sets with e-SV are certified for use with drinking water according to WRAS and ACS standards, and with Italian Ministry Decree no. 174.

TWO-PUMP BOOSTER SETS, GVF11 SERIES VERTICAL ELECTRIC PUMPS WITH NON-RETURN VALVE ON DISCHARGE SIDE

**GVF11D
GVF11Y**

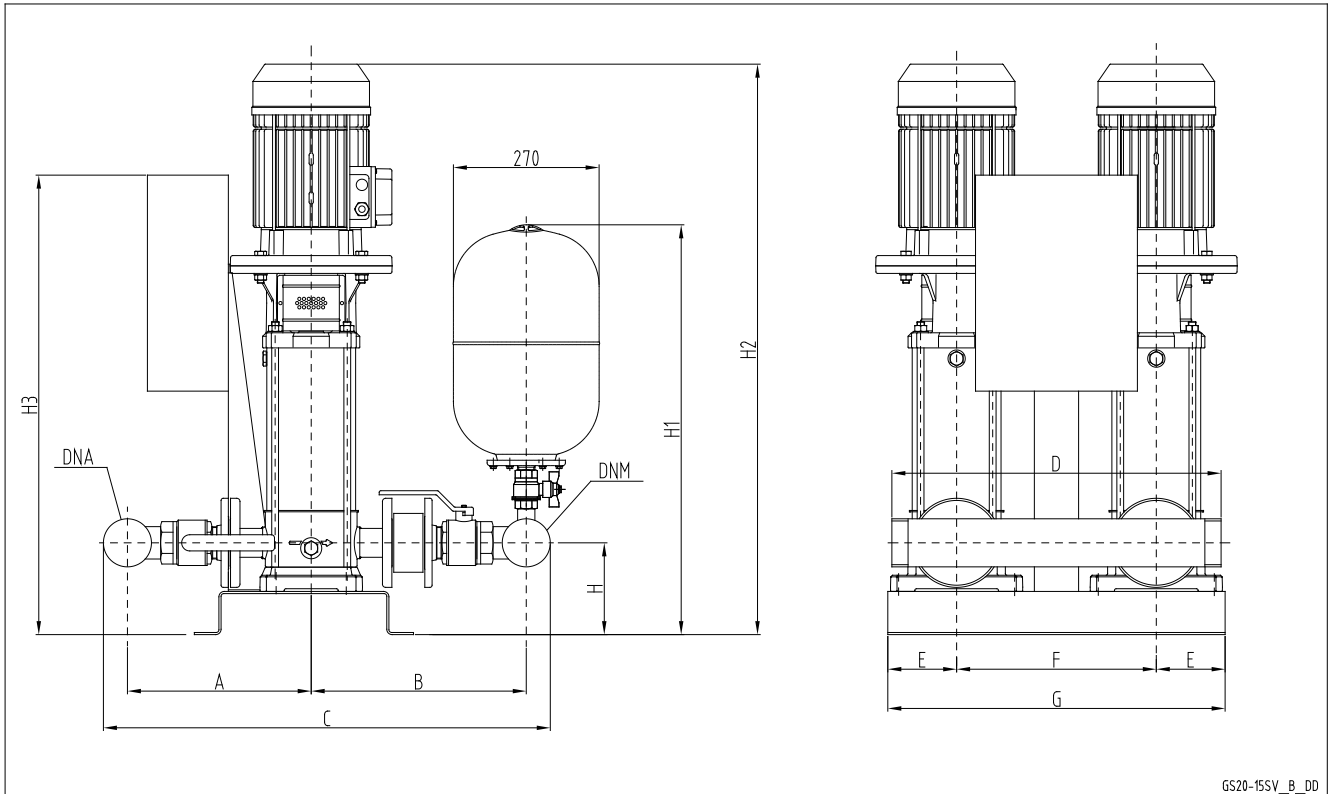

GS20-15SV_B_DD

GVF11	DNA	DNM	A		B		C		D	E	F	G	H	H1	H2	H3
			STD/DW	AISI	STD/DW	AISI	STD/DW	AISI								
15SV06F055T	R 3"	R 3"	342	382	399	437	829	907	610	135	370	640	170	765	1133	1570
15SV07F055T	R 3"	R 3"	342	382	399	437	829	907	610	135	370	640	170	765	1181	1570
15SV08F075T	R 3"	R 3"	342	382	399	437	829	907	610	135	370	640	170	765	1221	1570
15SV09F075T	R 3"	R 3"	342	382	399	437	829	907	610	135	370	640	170	765	1269	1570
15SV10F110T	R 3"	R 3"	342	382	399	437	829	907	680	260	440	960	200	795	1438	1570
22SV05F055T	R 3"	R 3"	342	382	399	437	829	907	610	135	370	640	170	765	1085	1570
22SV06F075T	R 3"	R 3"	342	382	399	437	829	907	610	135	370	640	170	765	1125	1570
22SV07F075T	R 3"	R 3"	342	382	399	437	829	907	610	135	370	640	170	765	1173	1570
22SV08F110T	R 3"	R 3"	342	382	399	437	829	907	680	260	440	960	200	795	1342	1570
22SV09F110T	R 3"	R 3"	342	382	399	437	829	907	680	260	440	960	200	795	1390	1570
22SV10F110T	R 3"	R 3"	342	382	399	437	829	907	680	260	440	960	200	795	1438	1570

Dimensions in mm. Tolerance ± 10 mm.

AISI: same dimensions /A304, /A316

Note: for version with vibration damping, feet increase height by 30mm

gvf11_15sv-new_b_td

TWO-PUMP BOOSTER SETS, GVF11 SERIES
VERTICAL ELECTRIC PUMPS WITH NON-RETURN VALVE ON DISCHARGE SIDE

GVF11D
GVF11Y

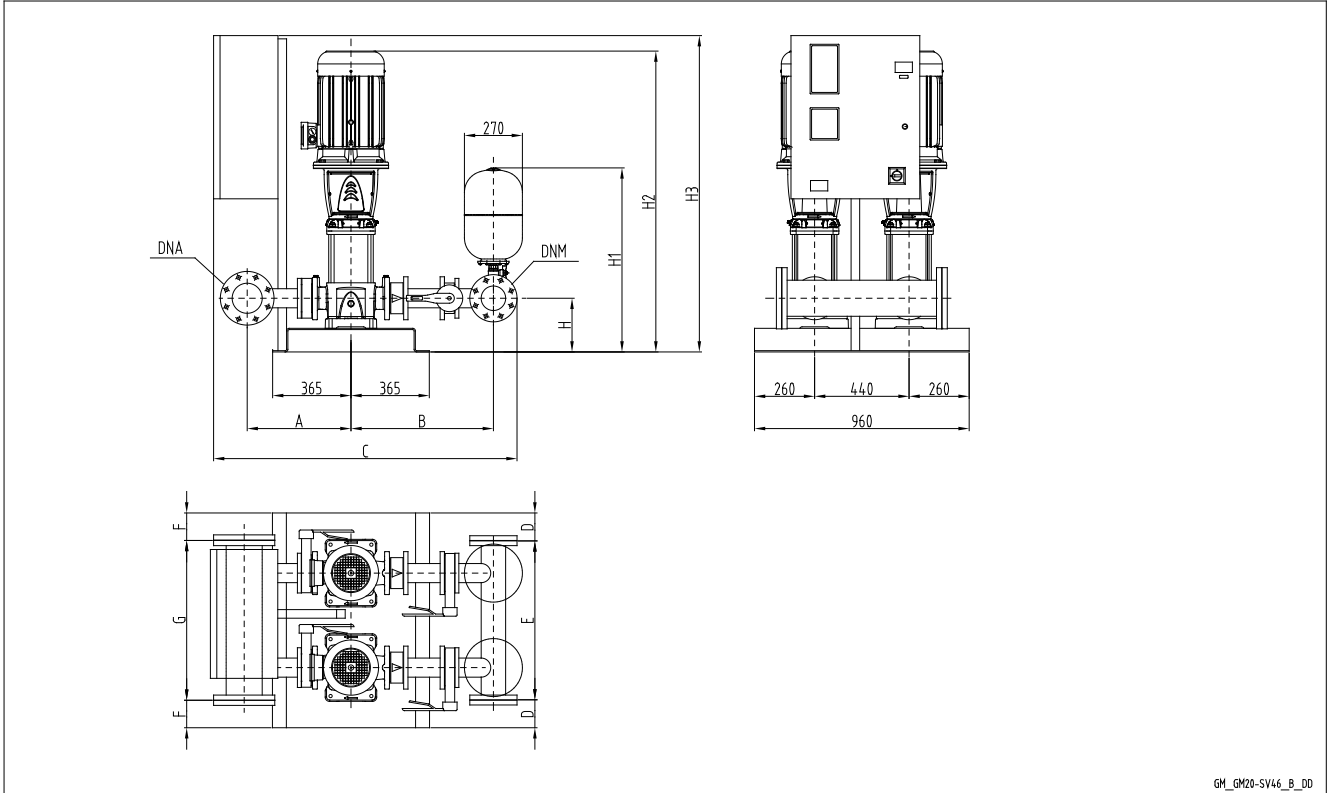

GM_GM20-SV46_B_DD

TWO-PUMP BOOSTER SETS, GVF11 SERIES
VERTICAL ELECTRIC PUMPS WITH NON-RETURN VALVE ON DISCHARGE SIDE

GVF11	DNA	DNM	A	B	C	D	E	F	G	H	H1	H2	H3
33SV1/1AG022T	100	80	448	701	1401	90	780	90	780	215	810	897	1321
33SV1G030T	100	80	448	701	1401	90	780	90	780	215	810	897	1321
33SV2/2AG040T	100	80	448	701	1401	90	780	90	780	215	810	993	1321
33SV2/1AG040T	100	80	448	701	1401	90	780	90	780	215	810	993	1321
33SV2G055T	100	80	448	701	1401	90	780	90	780	215	810	1069	1321
33SV3/2AG055T	100	80	448	701	1401	90	780	90	780	215	810	1144	1321
33SV3/1AG075T	100	80	448	701	1451	90	780	90	780	215	810	1136	1321
33SV3G075T	100	80	448	701	1451	90	780	90	780	215	810	1136	1321
33SV4/2AG075T	100	80	448	701	1451	90	780	90	780	215	810	1211	1321
33SV4/1AG110T	100	80	448	701	1451	90	780	90	780	215	810	1307	1571
33SV4G110T	100	80	448	701	1451	90	780	90	780	215	810	1307	1571
33SV5/2AG110T	100	80	448	701	1451	90	780	90	780	215	810	1382	1571
33SV5/1AG110T	100	80	448	701	1451	90	780	90	780	215	810	1382	1571
33SV5G150T	100	80	448	701	1451	90	780	90	780	215	810	1448	1571
33SV6/2AG150T	100	80	448	701	1451	90	780	90	780	215	810	1523	1571
33SV6/1AG150T	100	80	448	701	1451	90	780	90	780	215	810	1523	1571
33SV6G150T	100	80	448	701	1451	90	780	90	780	215	810	1523	1571
33SV7/2AG150T	100	80	448	701	1451	90	780	90	780	215	810	1598	1571
46SV1/1AG030T	125	100	484	739	1457	90	780	90	780	250	857	937	1321
46SV1G040T	125	100	484	739	1457	90	780	90	780	250	857	958	1321
46SV2/2AG055T	125	100	484	739	1457	90	780	90	780	250	857	1109	1321
46SV2G075T	125	100	484	739	1499	90	780	90	780	250	857	1101	1321
46SV3/2AG110T	125	100	484	739	1499	90	780	90	780	250	857	1272	1571
46SV3G110T	125	100	484	739	1499	90	780	90	780	250	857	1272	1571
46SV4/2AG150T	125	100	484	739	1499	90	780	90	780	250	857	1413	1571
46SV4G150T	125	100	484	739	1499	90	780	90	780	250	857	1413	1571
66SV1/1AG040T	150	125	504	780	1551	90	780	70	820	250	870	983	1321
66SV1G055T	150	125	504	780	1551	90	780	70	820	250	870	1059	1321
66SV2/2AG075T	150	125	504	780	1555	90	780	70	820	250	870	1141	1321
66SV2/1AG110T	150	125	504	780	1555	90	780	70	820	250	870	1237	1571
66SV2G110T	150	125	504	780	1555	90	780	70	820	250	870	1237	1571
66SV3/2AG150T	150	125	504	780	1555	90	780	70	820	250	870	1393	1571
66SV3/1AG150T	150	125	504	780	1555	90	780	70	820	250	870	1393	1571
92SV1/1AG055T	200	150	529	794	1635	70	820	70	820	250	884	1059	1321
92SV1G075T	200	150	529	794	1635	70	820	70	820	250	884	1051	1321
92SV2/2AG110T	200	150	529	794	1635	70	820	70	820	250	884	1237	1571
92SV2G150T	200	150	529	794	1635	70	820	70	820	250	884	1303	1571

Dimensions in mm. Tolerance ± 10 mm.
Note: for version with vibration damping, feet increase height by 50mm

gvf11_sv46_b_td

GVF11D
GVF11Y

TWO-PUMP BOOSTER SETS, GVF11 SERIES VERTICAL ELECTRIC PUMPS WITH NON-RETURN VALVE ON DISCHARGE SIDE

GVF11D
GVF11Y

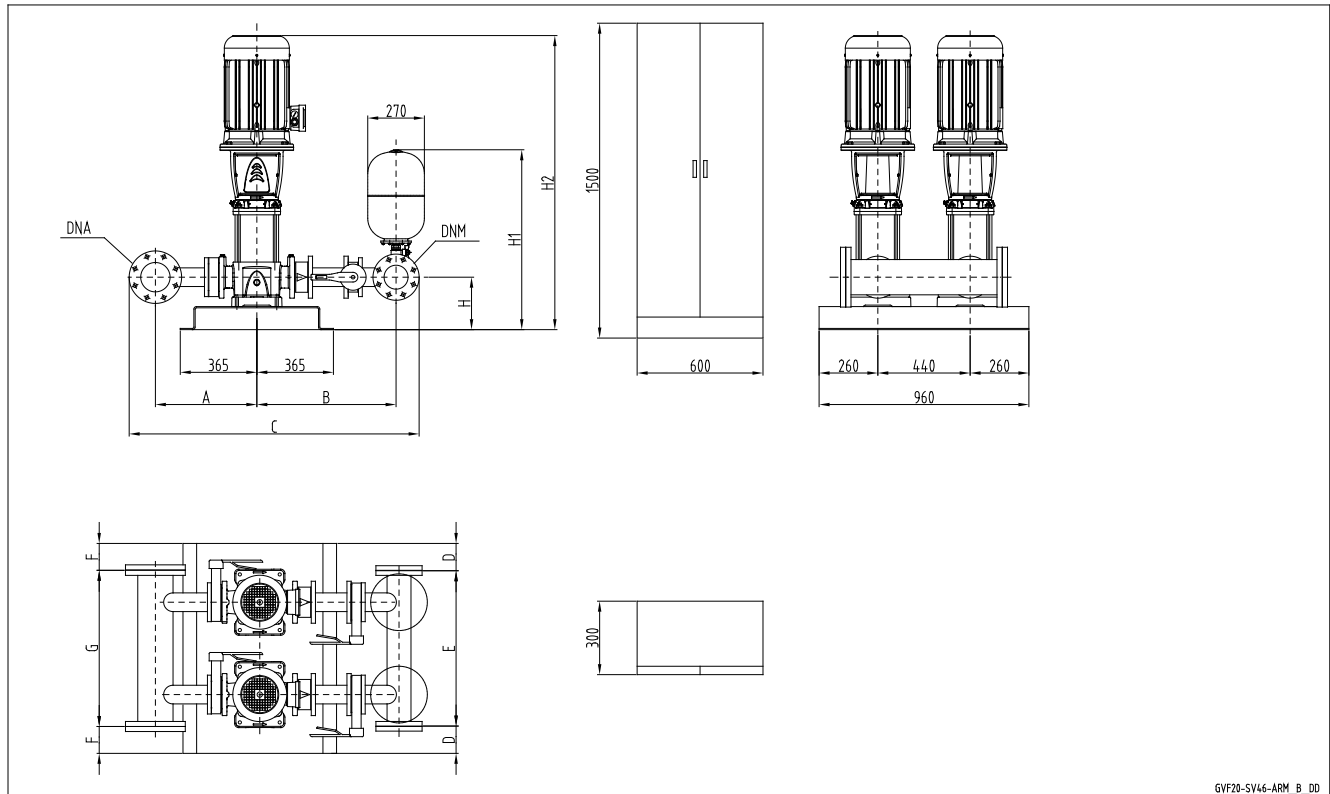

GVF20-SV46-ARM_B_DD

GVF11	DNA	DNM	A	B	C	D	E	F	G	H	H1	H2
46SV5/2AG185T	125	100	484	739	1457	90	780	90	780	250	857	1488
46SV5G185T	125	100	484	739	1457	90	780	90	780	250	857	1488
46SV6/2AG220T	125	100	484	739	1457	90	780	90	780	250	857	1563
46SV6G220T	125	100	484	739	1457	90	780	90	780	250	857	1563
66SV3G185T	150	125	504	780	1551	90	780	70	820	250	870	1393
66SV4/2AG185T	150	125	504	780	1551	90	780	70	820	250	870	1483
66SV4/1AG220T	150	125	504	780	1551	90	780	70	820	250	870	1483
66SV4G220T	150	125	504	780	1551	90	780	70	820	250	870	1483
92SV3/2AG185T	200	150	529	794	1635	70	820	70	820	250	884	1393
92SV3G220T	200	150	529	794	1635	70	820	70	820	250	884	1393

Dimensions in mm. Tolerance ± 10 mm.

Note: for version with vibration damping, feet increase height by 50mm

gvf11_sv46-arm_a_td

TWO-PUMP BOOSTER SETS, GVF11 SERIES
VERTICAL ELECTRIC PUMPS WITH NON-RETURN VALVE ON DISCHARGE SIDE

GVF11D
GVF11Y

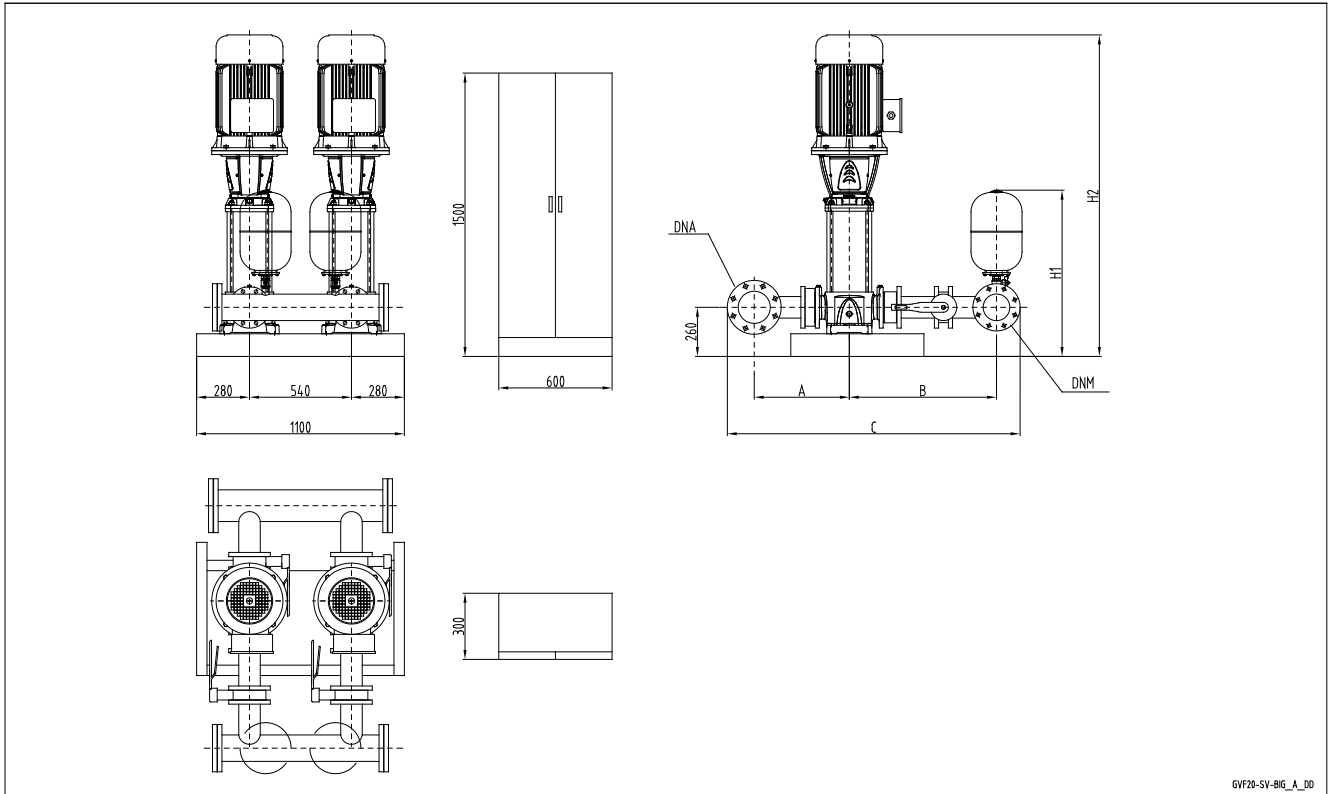

GVF20-SV-BIG_A_DD

GVF11	DNA	DNM	A	B	C	H1	H2
66SV5/2AG300T	150	125	504	780	1552	880	1702
66SV5/1AG300T	150	125	504	780	1552	880	1702
66SV5G300T	150	125	504	780	1552	880	1702
92SV4/2AG300T	200	150	529	794	1635	894	1612
92SV4G300T	200	150	529	794	1635	894	1612
92SV5/2AG370T	200	150	529	794	1635	894	1702

Dimensions in mm. Tolerance ± 10 mm.

Note: for version with vibration damping, feet increase height by 50mm

gvf11_sv-big_a_td

TWO-PUMP BOOSTER SETS, GVF11 SERIES
VERTICAL ELECTRIC PUMPS WITH NON-RETURN VALVE ON DISCHARGE SIDE

GVF11D
GVF11Y

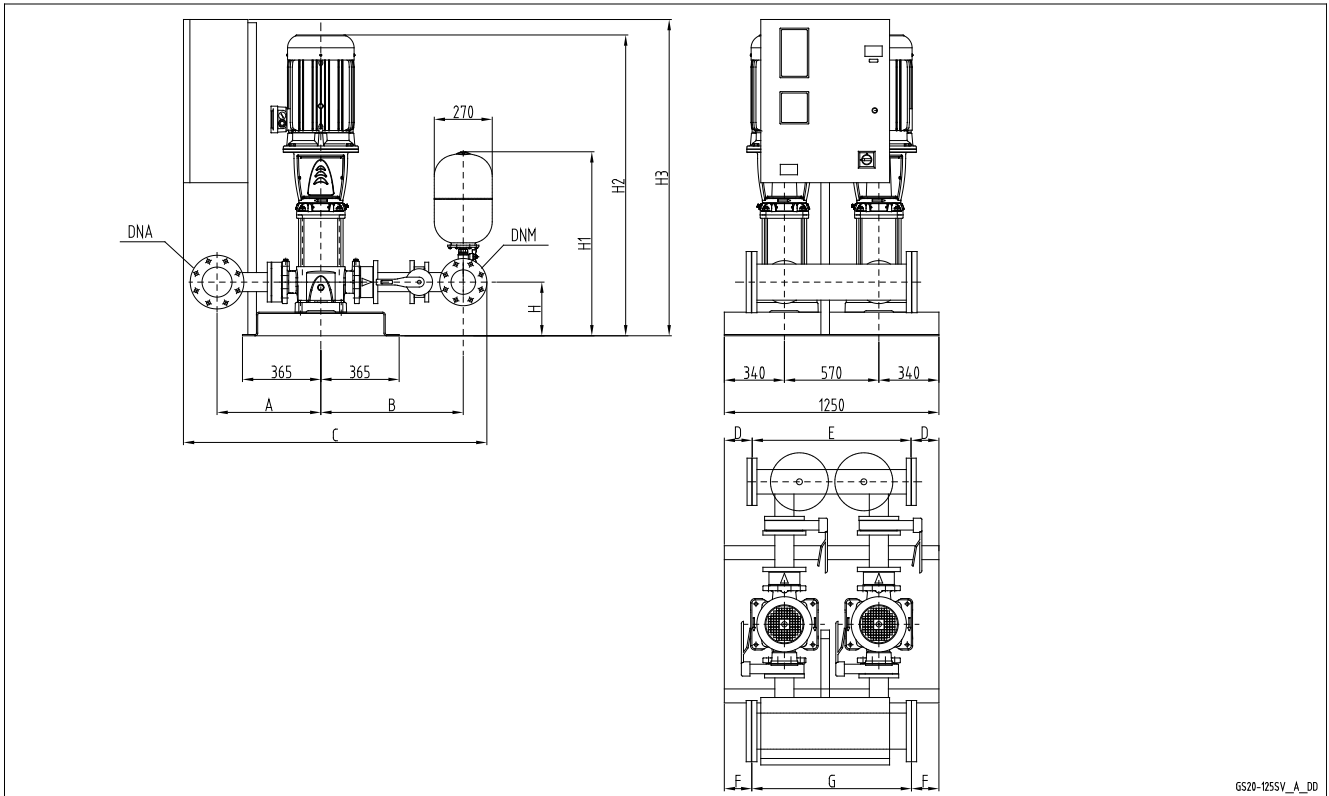

GS20-125SV_A_DD

GVF11	DNA	DNM	A	B	C	D	E	F	G	H	H1	H2	H3
125SV1G075T	200	200	591	927	1857	150	950	150	950	280	940	1180	1322
125SV2G150T	200	200	591	927	1857	150	950	150	950	280	940	1492	1572

Dimensions in mm. Tolerance ± 10 mm.
Note: for version with vibration damping, feet increase height by 50mm

gvf11_125sv_a_td

TWO-PUMP BOOSTER SETS, GVF11 SERIES
VERTICAL ELECTRIC PUMPS WITH NON-RETURN VALVE ON DISCHARGE SIDE

GVF11D
GVF11Y

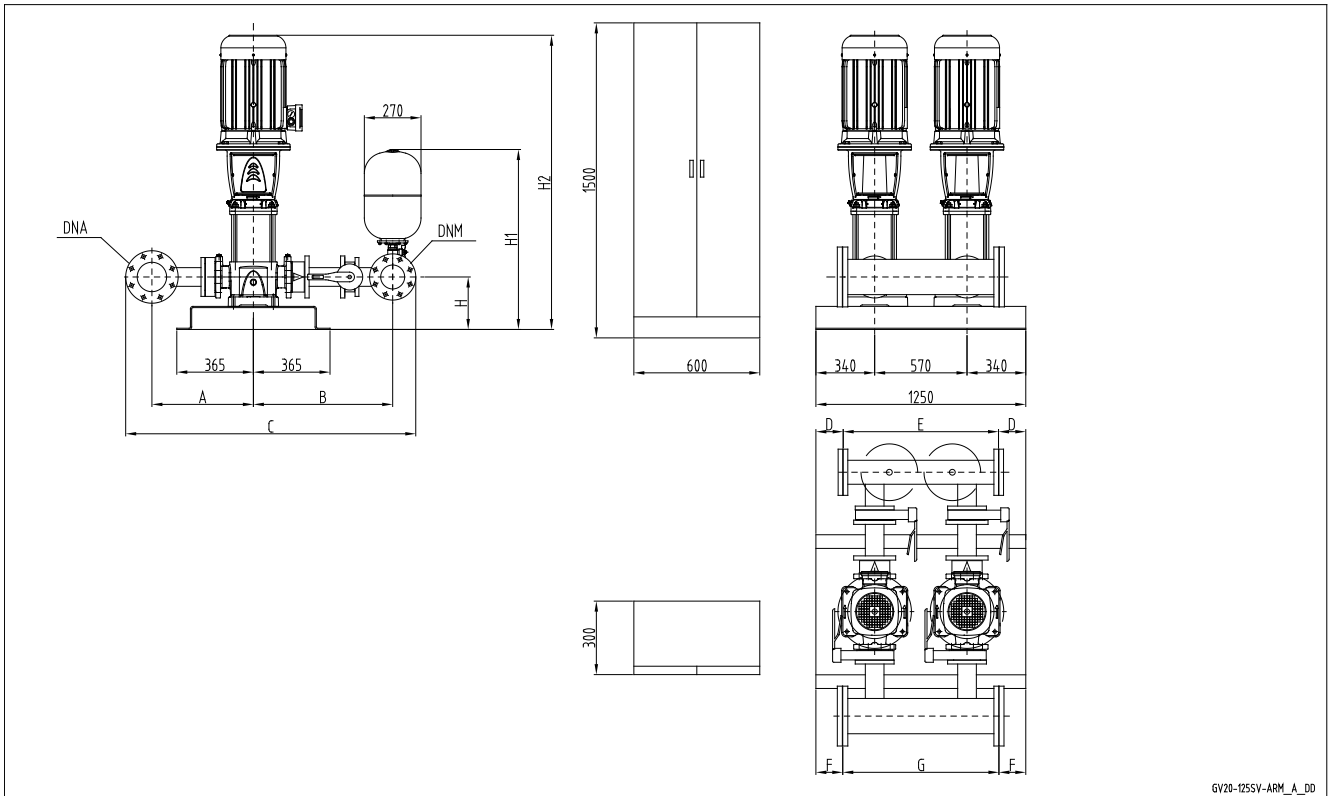

GVF11	DNA	DNM	A	B	C	D	E	F	G	H	H1	H2
125SV3G220T	200	200	591	927	1857	150	950	150	950	280	940	1642

Dimensions in mm. Tolerance ± 10 mm.

Note: for version with vibration damping, feet increase height by 50mm

gvf11_125sv-arm_a_td

TWO-PUMP BOOSTER SETS, GVF11 SERIES
VERTICAL ELECTRIC PUMPS WITH NON-RETURN VALVE ON DISCHARGE SIDE

GVF11D
GVF11Y

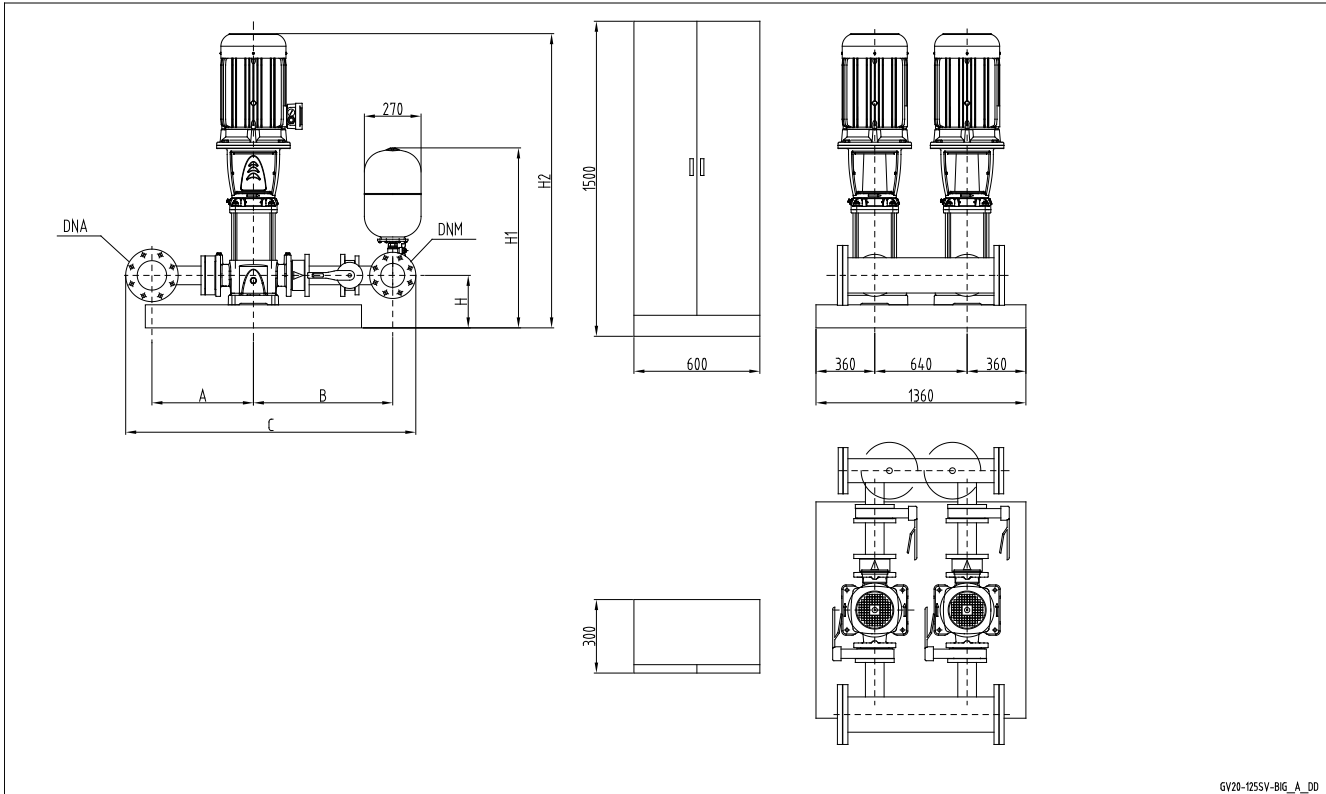

GVF11	DNA	DNM	A	B	C	H	H1	H2
125SV4G300T	200	200	591	927	1857	300	960	1975
125SV5G370T	200	200	591	927	1857	300	960	2125

Dimensions in mm. Tolerance ± 10 mm.

Note: for version with vibration damping, feet increase height by 50mm

gvf11_125sv-big_a_td

Booster sets

MARKET SECTORS
RESIDENTIAL-CIVIL, INDUSTRIAL

APPLICATIONS

- Water network supply in housing complexes, offices, hotels, shopping centres, industrial plants.
- Supply of water networks for agricultural applications (e.g. irrigation).

GVF12...D GVF12...R Series

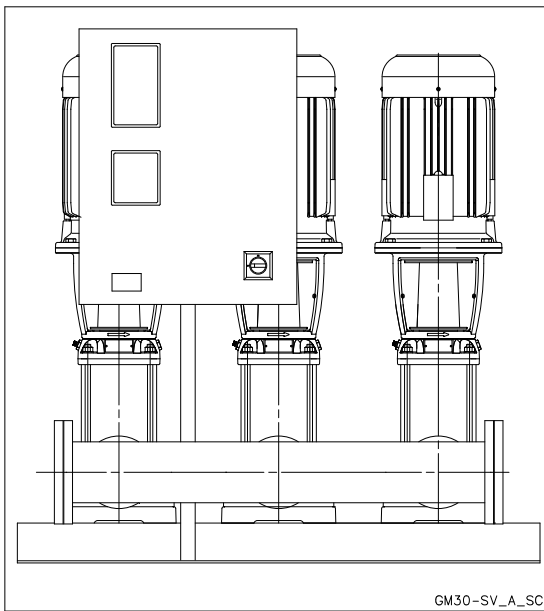

GVF12D
GVF12Y

SPECIFICATIONS

- **Flow rate:**
up to 480 m³/h.
- **Head:**
up to 160 m.
- **Electrical panel supply voltage:**
3 x 400V ± 10%.
- **Frequency:**
50 Hz.
- **Voltage for controls outside panel:**
24 Vac.
- **Electrical panel and electric pump protection class**
IP 55.
- **Maximum service pump power:**
3 x 37 kW.
- **Starting fixed-speed motors:**
 - Direct for powers up to 22 kW inclusive for pump (GVF...D).
 - Star/Delta on request (GVF...Y set).
 - Softstarter, for higher powers (GVF...R set).
- **Electric pumps with vertical axis:**
- SV series (motor protection class IP55).
- **Maximum operating pressure:**
16 bar.
- **Maximum temperature of pumped liquid :**
+80°C.

GVF series booster sets with e-SV are certified for use with drinking water according to WRAS and ACS standards, and with Italian Ministry Decree no. 174.

THREE-PUMP BOOSTER SETS, GVF12 SERIES VERTICAL ELECTRIC PUMPS WITH NON-RETURN VALVE ON DISCHARGE SIDE

GVF12D
GVF12Y

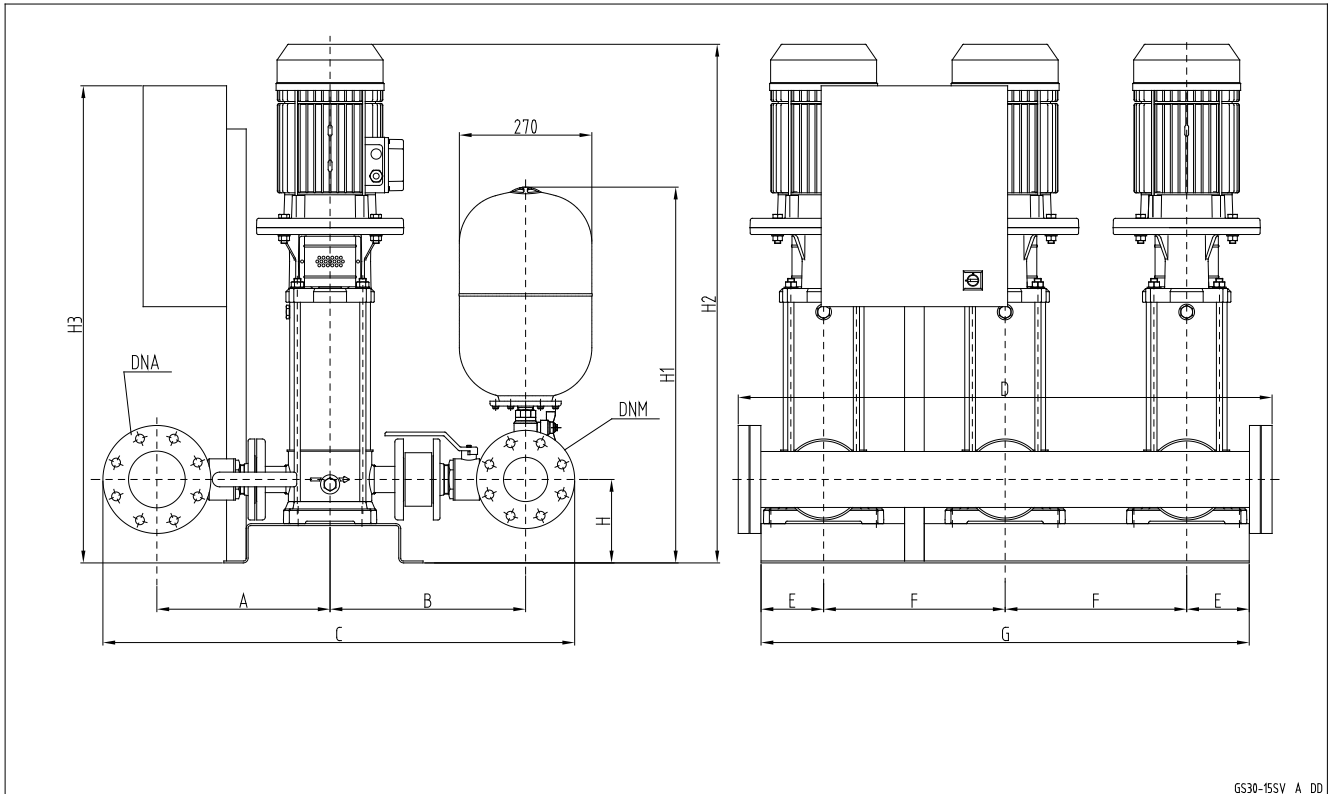

GS30-15SV_A_DD

GVF12	DNA	DNM	A		B		C		D	E	F	G	H	H1	H2	H3
			STD/DW	AISI	STD/DW	AISI	STD/DW	AISI								
15SV02F022T	100	80	354	394	399	437	963	1041	1084	128	370	995	170	765	787	1570
15SV03F030T	100	80	354	394	399	437	963	1041	1084	128	370	995	170	765	845	1570
15SV04F040T	100	80	354	394	399	437	963	1041	1084	128	370	995	170	765	914	1570
15SV05F040T	100	80	354	394	399	437	963	1041	1084	128	370	995	170	765	962	1570
15SV06F055T	100	80	354	394	399	437	963	1041	1084	128	370	995	170	765	1133	1570
15SV07F055T	100	80	354	394	399	437	963	1041	1084	128	370	995	170	765	1181	1570
15SV08F075T	100	80	354	394	399	437	963	1041	1084	128	370	995	170	765	1221	1570
15SV09F075T	100	80	354	394	399	437	963	1041	1084	128	370	995	170	765	1269	1570
15SV10F110T	100	80	354	394	399	437	963	1041	1224	260	440	1400	200	795	1438	1570
22SV02F022T	100	100	354	394	411	449	985	1063	1084	128	370	995	170	777	787	1570
22SV03F030T	100	100	354	394	411	449	985	1063	1084	128	370	995	170	777	845	1570
22SV04F040T	100	100	354	394	411	449	985	1063	1084	128	370	995	170	777	914	1570
22SV05F055T	100	100	354	394	411	449	985	1063	1084	128	370	995	170	777	1085	1570
22SV06F075T	100	100	354	394	411	449	985	1063	1084	128	370	995	170	777	1125	1570
22SV07F075T	100	100	354	394	411	449	985	1063	1084	128	370	995	170	777	1173	1570
22SV08F110T	100	100	354	394	411	449	985	1063	1224	260	440	1400	200	807	1342	1570
22SV09F110T	100	100	354	394	411	449	985	1063	1224	260	440	1400	200	807	1390	1570
22SV10F110T	100	100	354	394	411	449	985	1063	1224	260	440	1400	200	807	1438	1570

Dimensions in mm. Tolerance ± 10 mm.

AISI: same dimensions /A304, /A316

Note: for version with vibration damping, feet increase height by 30mm

gvf12_15sv-new_c_td

**THREE-PUMP BOOSTER SETS, GVF12 SERIES
VERTICAL ELECTRIC PUMPS WITH NON-RETURN VALVE ON DISCHARGE SIDE**

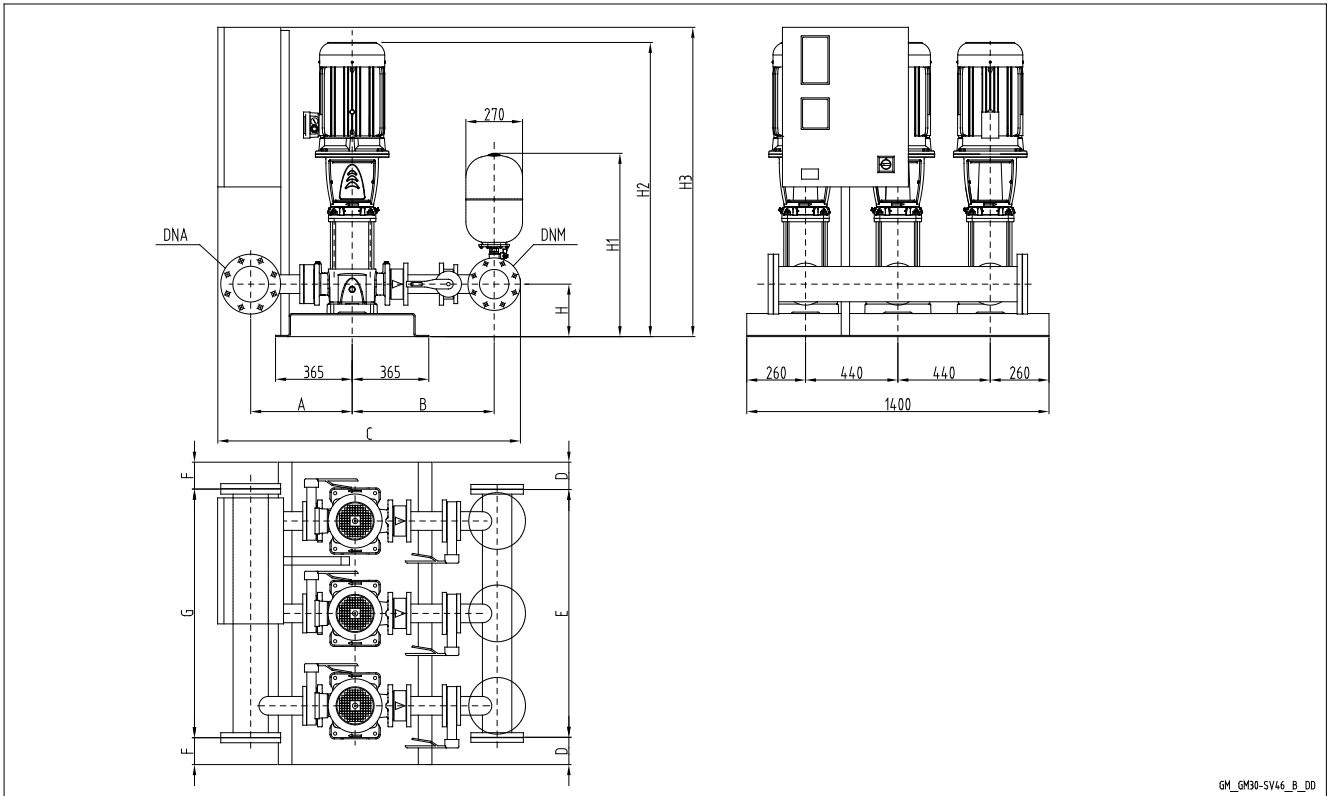

GM_GM30-SV46_B_DD

**GVF12D
GVF12Y**

THREE-PUMP BOOSTER SETS, GVF12 SERIES
VERTICAL ELECTRIC PUMPS WITH NON-RETURN VALVE ON DISCHARGE SIDE

GVF12	DNA	DNM	A	B	C	D	E	F	G	H	H1	H2	H3
33SV1/1AG022T	125	100	461	713	1423	90	1220	90	1220	215	822	897	1321
33SV1G030T	125	100	461	713	1423	90	1220	90	1220	215	822	897	1321
33SV2/2AG040T	125	100	461	713	1423	90	1220	90	1220	215	822	993	1321
33SV2/1AG040T	125	100	461	713	1423	90	1220	90	1220	215	822	993	1321
33SV2G055T	125	100	461	713	1423	90	1220	90	1220	215	822	1069	1321
33SV3/2AG055T	125	100	461	713	1423	90	1220	90	1220	215	822	1144	1321
33SV3/1AG075T	125	100	461	713	1423	90	1220	90	1220	215	822	1136	1571
33SV3G075T	125	100	461	713	1423	90	1220	90	1220	215	822	1136	1571
33SV4/2AG075T	125	100	461	713	1423	90	1220	90	1220	215	822	1211	1571
33SV4/1AG110T	125	100	461	713	1473	90	1220	90	1220	215	822	1307	1571
33SV4G110T	125	100	461	713	1473	90	1220	90	1220	215	822	1307	1571
33SV5/2AG110T	125	100	461	713	1473	90	1220	90	1220	215	822	1382	1571
33SV5/1AG110T	125	100	461	713	1473	90	1220	90	1220	215	822	1382	1571
33SV5G150T	125	100	461	713	1473	90	1220	90	1220	215	822	1448	1571
33SV6/2AG150T	125	100	461	713	1473	90	1220	90	1220	215	822	1523	1571
33SV6/1AG150T	125	100	461	713	1473	90	1220	90	1220	215	822	1523	1571
33SV6G150T	125	100	461	713	1473	90	1220	90	1220	215	822	1523	1571
33SV7/2AG150T	125	100	461	713	1473	90	1220	90	1220	215	822	1598	1571
46SV1/1AG030T	150	125	498	752	1517	90	1220	70	1260	250	870	937	1321
46SV1G040T	150	125	498	752	1517	90	1220	70	1260	250	870	958	1321
46SV2/2AG055T	150	125	498	752	1517	90	1220	70	1260	250	870	1109	1321
46SV2G075T	150	125	498	752	1517	90	1220	70	1260	250	870	1101	1571
46SV3/2AG110T	150	125	498	752	1527	90	1220	70	1260	250	870	1272	1571
46SV3G110T	150	125	498	752	1527	90	1220	70	1260	250	870	1272	1571
46SV4/2AG150T	150	125	498	752	1527	90	1220	70	1260	250	870	1413	1571
46SV4G150T	150	125	498	752	1527	90	1220	70	1260	250	870	1413	1571
66SV1/1AG040T	200	150	529	794	1635	70	1260	70	1260	250	884	983	1321
66SV1G055T	200	150	529	794	1635	70	1260	70	1260	250	884	1059	1321
66SV2/2AG075T	200	150	529	794	1635	70	1260	70	1260	250	884	1141	1571
66SV2/1AG110T	200	150	529	794	1635	70	1260	70	1260	250	884	1237	1571
66SV2G110T	200	150	529	794	1635	70	1260	70	1260	250	884	1237	1571
66SV3/2AG150T	200	150	529	794	1635	70	1260	70	1260	250	884	1393	1571
66SV3/1AG150T	200	150	529	794	1635	70	1260	70	1260	250	884	1393	1571
92SV1/1AG055T	200	200	529	819	1688	70	1260	70	1260	250	910	1059	1321
92SV1G075T	200	200	529	819	1688	70	1260	70	1260	250	910	1051	1571
92SV2/2AG110T	200	200	529	819	1688	70	1260	70	1260	250	910	1237	1571
92SV2G150T	200	200	529	819	1688	70	1260	70	1260	250	910	1303	1571

Dimensions in mm. Tolerance ± 10 mm.

Note: for version with vibration damping, feet increase height by 50mm

gvf12_sv46_b_td

GVF12D
GVF12Y

THREE-PUMP BOOSTER SETS, GVF12 SERIES VERTICAL ELECTRIC PUMPS WITH NON-RETURN VALVE ON DISCHARGE SIDE

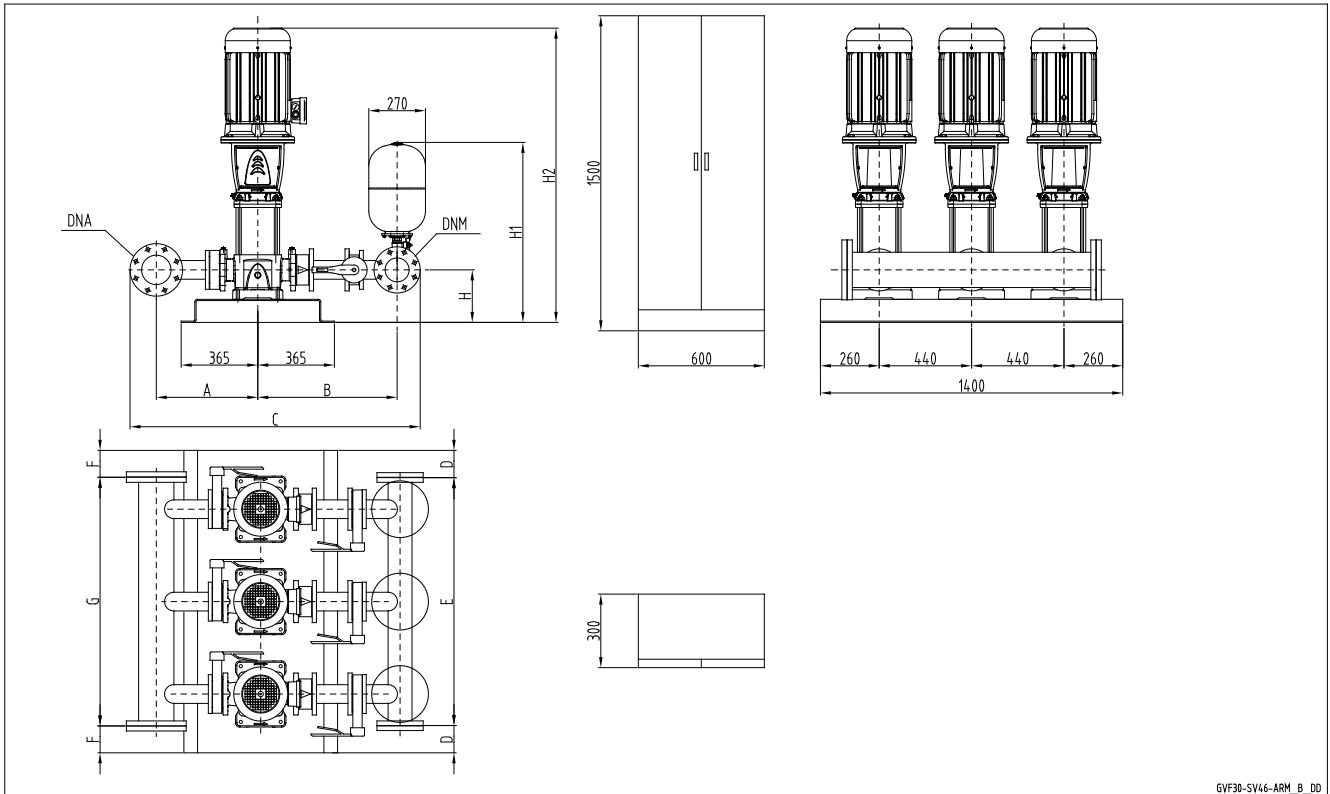

GVF30-SV46-ARM_B_DD

GVF12D
GVF12Y

GVF12	DNA	DNM	A	B	C	D	E	F	G	H	H1	H2
46SV5/2AG185T	150	125	498	752	1527	90	1220	70	1260	250	870	1488
46SV5G185T	150	125	498	752	1527	90	1220	70	1260	250	870	1488
46SV6/2AG220T	150	125	498	752	1527	90	1220	70	1260	250	870	1563
46SV6G220T	150	125	498	752	1527	90	1220	70	1260	250	870	1563
66SV3G185T	200	150	529	794	1635	70	1260	70	1260	250	884	1393
66SV4/2AG185T	200	150	529	794	1635	70	1260	70	1260	250	884	1483
66SV4/1AG220T	200	150	529	794	1635	70	1260	70	1260	250	884	1483
66SV4G220T	200	150	529	794	1635	70	1260	70	1260	250	884	1483
92SV3/2AG185T	200	200	529	819	1688	70	1260	70	1260	250	910	1393
92SV3G220T	200	200	529	819	1688	70	1260	70	1260	250	910	1393

Dimensions in mm. Tolerance ± 10 mm.

Note: for version with vibration damping, feet increase height by 50mm

gvf12_sv46-arm_a_td

THREE-PUMP BOOSTER SETS, GVF12 SERIES
VERTICAL ELECTRIC PUMPS WITH NON-RETURN VALVE ON DISCHARGE SIDE

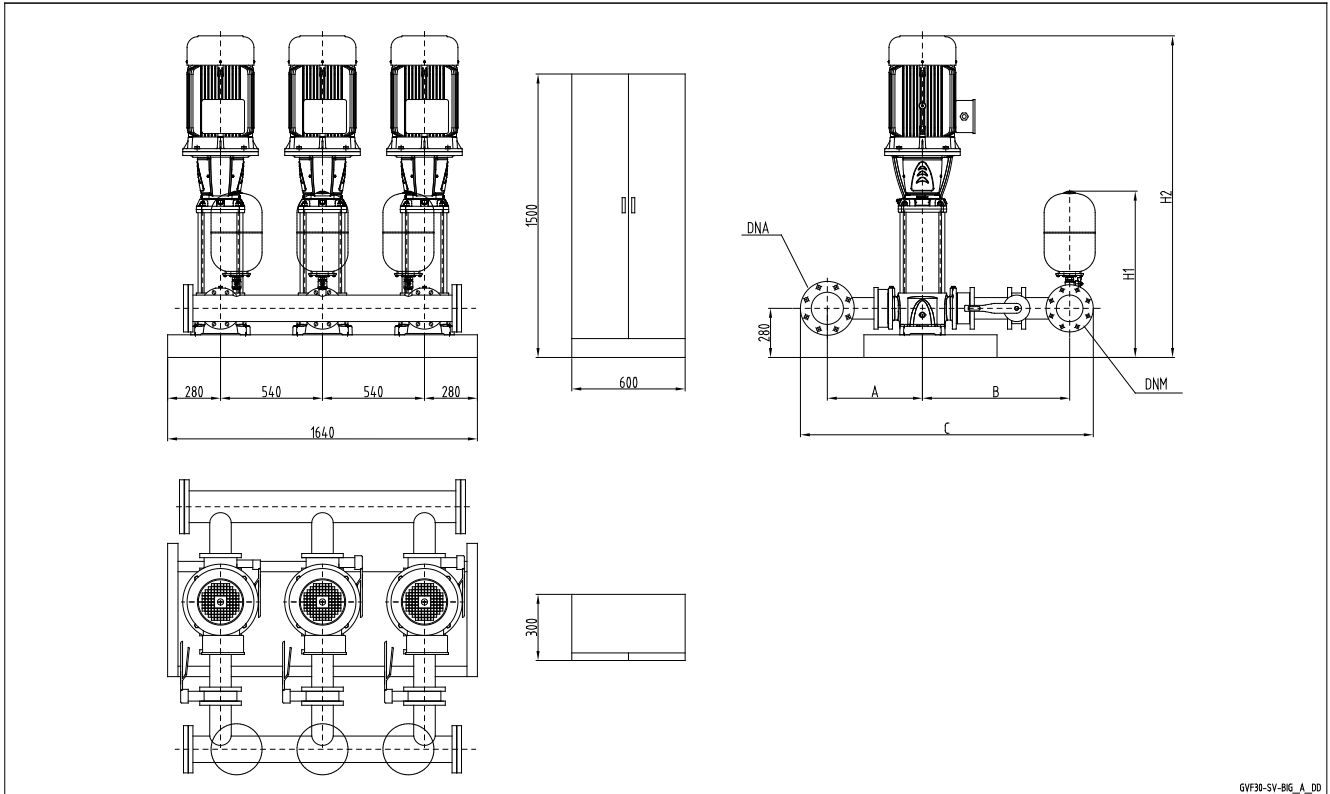

GVF30-SV-BIG_A_DD

GVF12D
GVF12Y

GVF12	DNA	DNM	A	B	C	H1	H2
66SV5/2AG300T	200	150	529	794	1635	914	1766
66SV5/1AG300T	200	150	529	794	1635	914	1766
66SV5G300T	200	150	529	794	1635	914	1766
92SV4/2AG300T	200	200	529	819	1688	940	1676
92SV4G300T	200	200	529	819	1688	940	1676
92SV5/2AG370T	200	200	529	819	1688	940	1766

Dimensions in mm. Tolerance ± 10 mm.

Note: for version with vibration damping, feet increase height by 50mm

gvf12_sv-big_b_td

THREE-PUMP BOOSTER SETS, GVF12 SERIES
VERTICAL ELECTRIC PUMPS WITH NON-RETURN VALVE ON DISCHARGE SIDE

GVF12D
GVF12Y

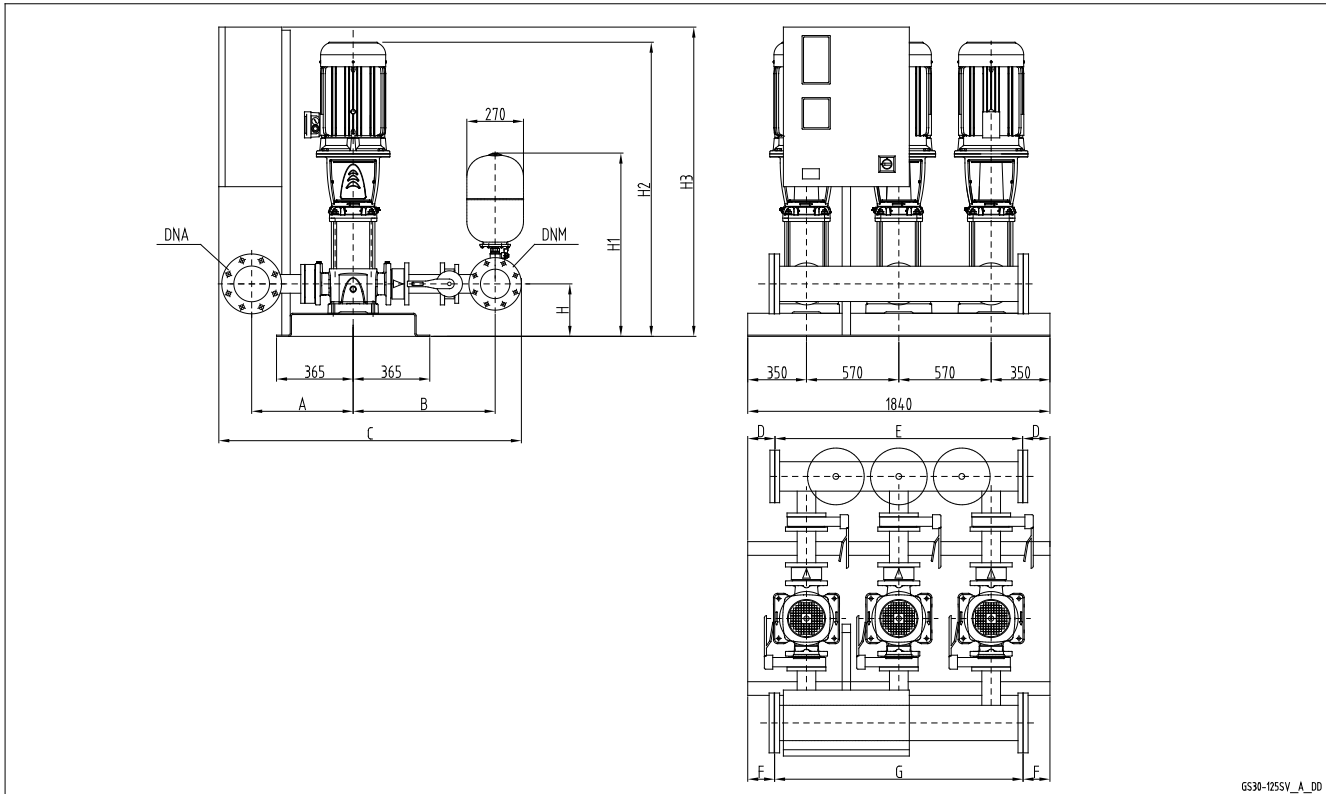

GVF12	DNA	DNM	A	B	C	D	E	F	G	H	H1	H2	H3
125SV1G075T	250	200	618	927	1917	160	1520	130	1580	280	940	1180	1572
125SV2G150T	250	200	618	927	1917	160	1520	130	1580	280	940	1492	1572

Dimensions in mm. Tolerance ± 10 mm.
Note: for version with vibration damping, feet increase height by 50mm

gvf12_125sv_a_td

THREE-PUMP BOOSTER SETS, GVF12 SERIES VERTICAL ELECTRIC PUMPS WITH NON-RETURN VALVE ON DISCHARGE SIDE

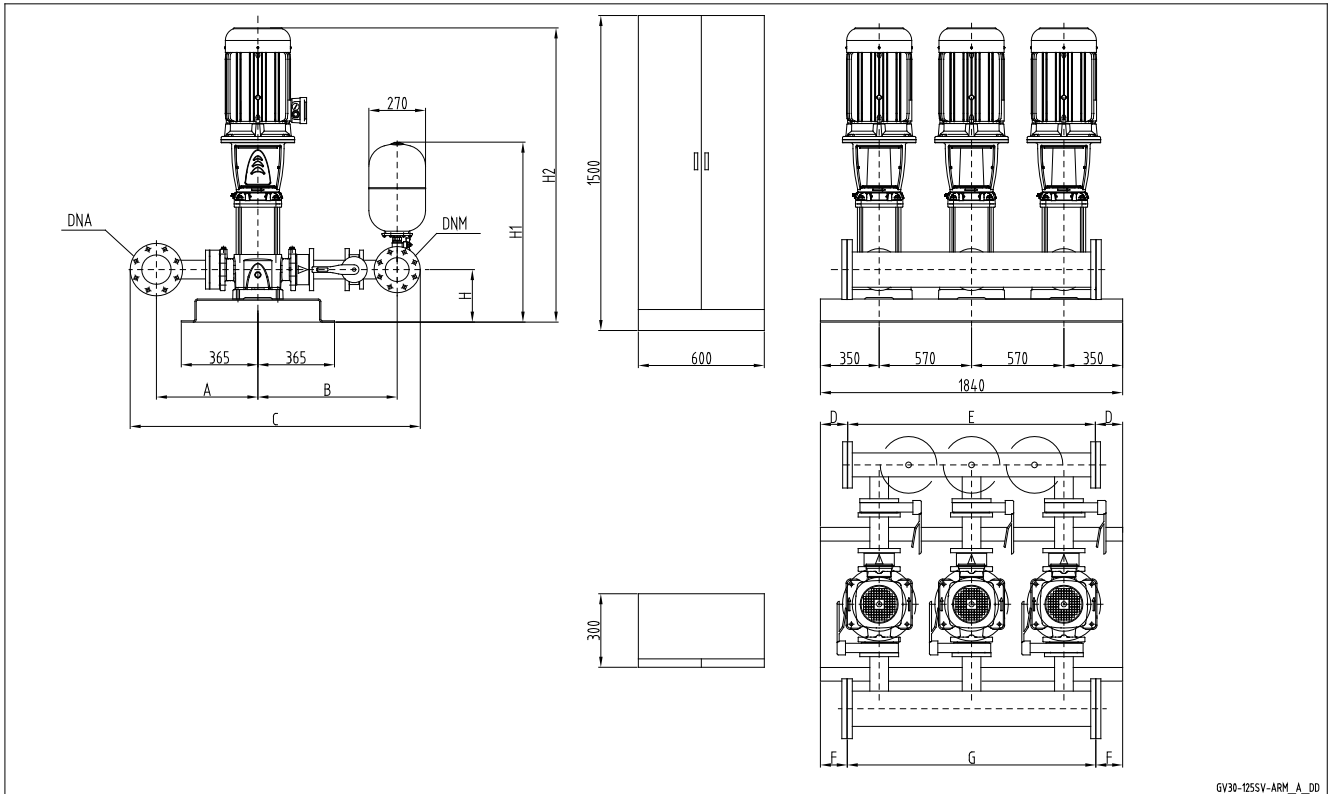

GV30-125SV-ARM_A_DD

GVF12D
GVF12Y

GVF12	DNA	DNM	A	B	C	D	E	F	G	H	H1	H2
125SV3G220T	250	200	618	927	1917	160	1520	130	1580	280	940	1642

Dimensions in mm. Tolerance ± 10 mm.

Note: for version with vibration damping, feet increase height by 50mm

gvf12_125sv-arm_a_td

THREE-PUMP BOOSTER SETS, GVF12 SERIES VERTICAL ELECTRIC PUMPS WITH NON-RETURN VALVE ON DISCHARGE SIDE

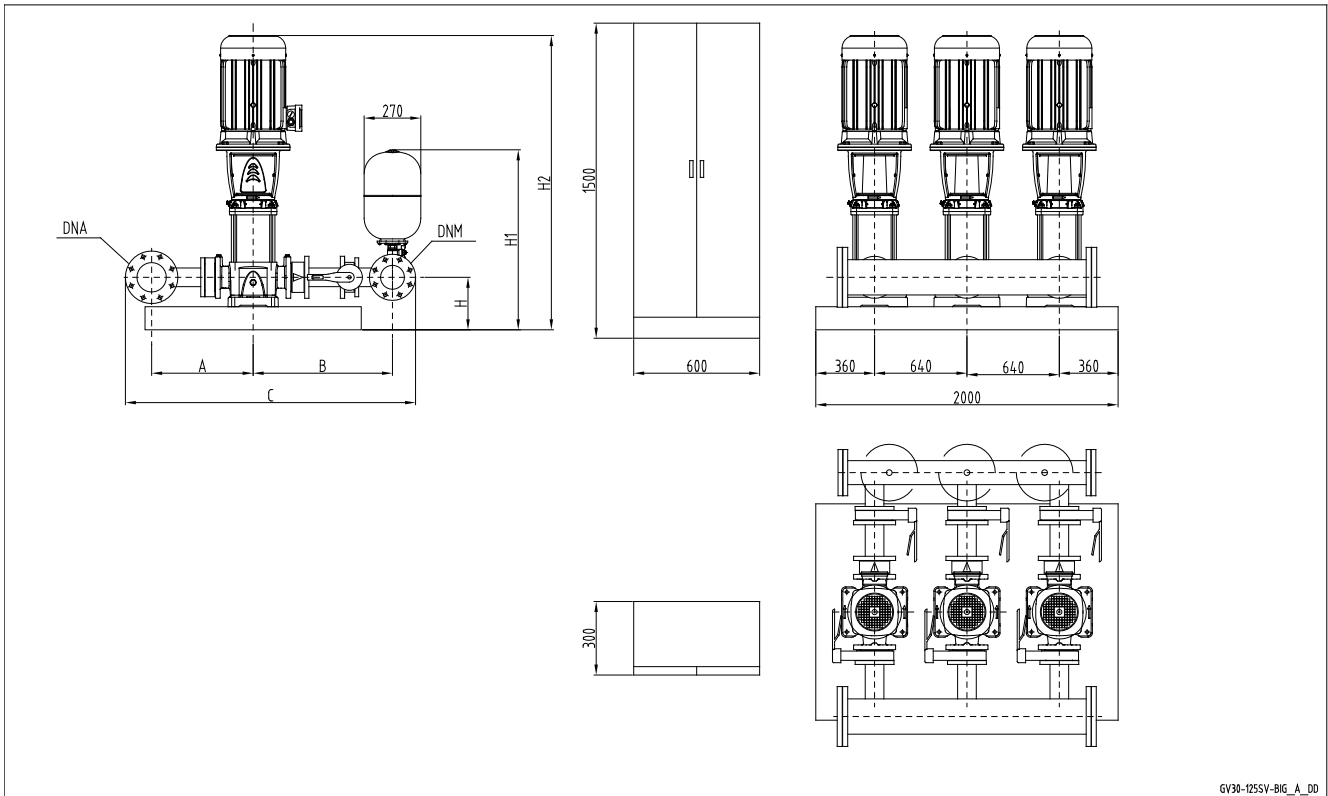

GV30-125SV-BIG_A_DD

GVF12D
GVF12Y

GVF12	DNA	DNM	A	B	C	H	H1	H2
125SV4G300T	250	200	618	927	1917	300	960	1975
125SV5G370T	250	200	618	927	1917	300	960	2125

Dimensions in mm. Tolerance ± 10 mm.

Note: for version with vibration damping, feet increase height by 50mm

gvf12_125sv-big_a_td

GVF12D
GVF12Y

Booster sets

MARKET SECTORS
RESIDENTIAL-CIVIL, INDUSTRIAL

APPLICATIONS

- Water network supply in housing complexes, offices, hotels, shopping centres, industrial plants.
- Supply of water networks for agricultural applications (e.g. irrigation).

GVF13...D GVF13...R Series

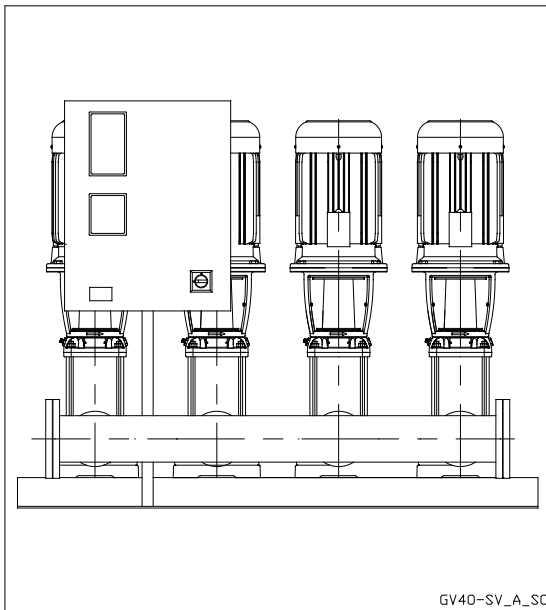

GVF13D
GVF13Y

SPECIFICATIONS

- **Flow rate:**
up to 640 m³/h.
- **Head:**
up to 160 m.
- **Electrical panel supply voltage:**
3 x 400V ± 10%.
- **Frequency:**
50 Hz.
- **Voltage for controls outside panel:**
24 Vac.
- **Electrical panel and electric pump protection class**
IP 55.
- **Maximum service pump power:**
4 x 37 kW.
- **Starting fixed-speed motors:**
 - Direct for powers up to 22 kW inclusive for pump (GVF...D).
 - Star/Delta on request (GVF...Y set).
 - Softstarter, for higher powers (GVF...R set).
- **Electric pumps with vertical axis:**
 - SV series (motor protection class IP55).
- **Maximum operating pressure:**
16 bar.
- **Maximum temperature of pumped liquid :**
+80°C.

GVF series booster sets with e-SV are certified for use with drinking water according to WRAS and ACS standards, and with Italian Ministry Decree no. 174.

FOUR-PUMP BOOSTER SETS, GVF13 SERIES VERTICAL ELECTRIC PUMPS WITH NON-RETURN VALVE ON DISCHARGE SIDE

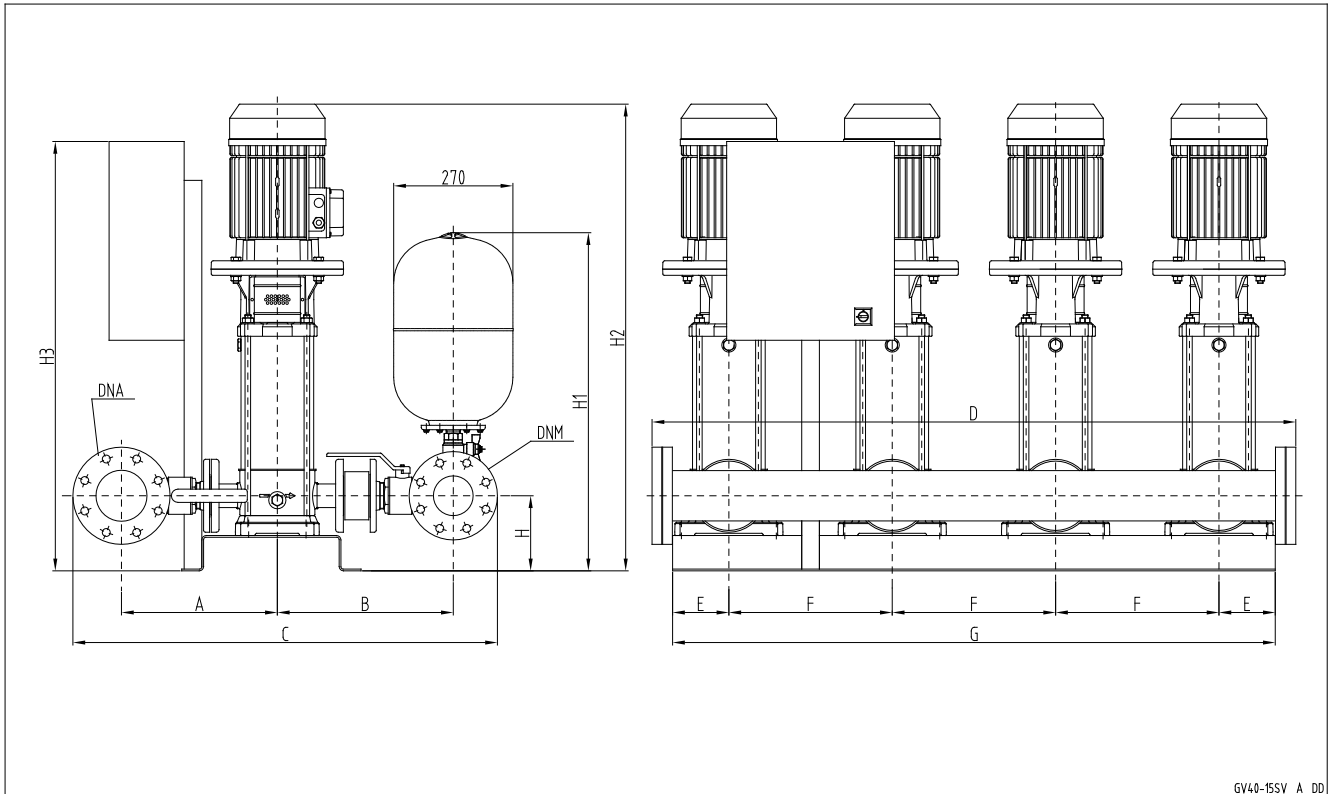

GV40-15SV_A_DD

GVF13D
GVF13Y

GVF13	DNA	DNM	A		B		C		D	E	F	G	H	H1	H2	H3
			STD/DW	AISI	STD/DW	AISI	STD/DW	AISI								
15SV02F022T	100	100	354	394	411	449	985	1063	1454	128	370	1365	170	777	787	1570
15SV03F030T	100	100	354	394	411	449	985	1063	1454	128	370	1365	170	777	845	1570
15SV04F040T	100	100	354	394	411	449	985	1063	1454	128	370	1365	170	777	914	1570
15SV05F040T	100	100	354	394	411	449	985	1063	1454	128	370	1365	170	777	962	1570
15SV06F055T	100	100	354	394	411	449	985	1063	1454	128	370	1365	170	777	1133	1570
15SV07F055T	100	100	354	394	411	449	985	1063	1454	128	370	1365	170	777	1181	1570
15SV08F075T	100	100	354	394	411	449	985	1063	1454	128	370	1365	170	777	1221	1820
15SV09F075T	100	100	354	394	411	449	985	1063	1454	128	370	1365	170	777	1269	1820
15SV10F110T	100	100	354	394	411	449	985	1063	1664	280	440	1880	200	807	1438	1820
22SV02F022T	125	100	367	407	411	449	1013	1091	1454	128	370	1365	170	777	787	1570
22SV03F030T	125	100	367	407	411	449	1013	1091	1454	128	370	1365	170	777	845	1570
22SV04F040T	125	100	367	407	411	449	1013	1091	1454	128	370	1365	170	777	914	1570
22SV05F055T	125	100	367	407	411	449	1013	1091	1454	128	370	1365	170	777	1085	1570
22SV06F075T	125	100	367	407	411	449	1013	1091	1454	128	370	1365	170	777	1125	1820
22SV07F075T	125	100	367	407	411	449	1013	1091	1454	128	370	1365	170	777	1173	1820
22SV08F110T	125	100	367	407	411	449	1013	1091	1664	280	440	1880	200	807	1342	1820
22SV09F110T	125	100	367	407	411	449	1013	1091	1664	280	440	1880	200	807	1390	1820
22SV10F110T	125	100	367	407	411	449	1013	1091	1664	280	440	1880	200	807	1438	1820

Dimensions in mm. Tolerance ± 10 mm.

AISI: same dimensions /A304, /A316

Note: for version with vibration damping, feet increase height by 30mm

gvf13_15sv-new_c_td

**FOUR-PUMP BOOSTER SETS, GVF13 SERIES
VERTICAL ELECTRIC PUMPS WITH NON-RETURN VALVE ON DISCHARGE SIDE**

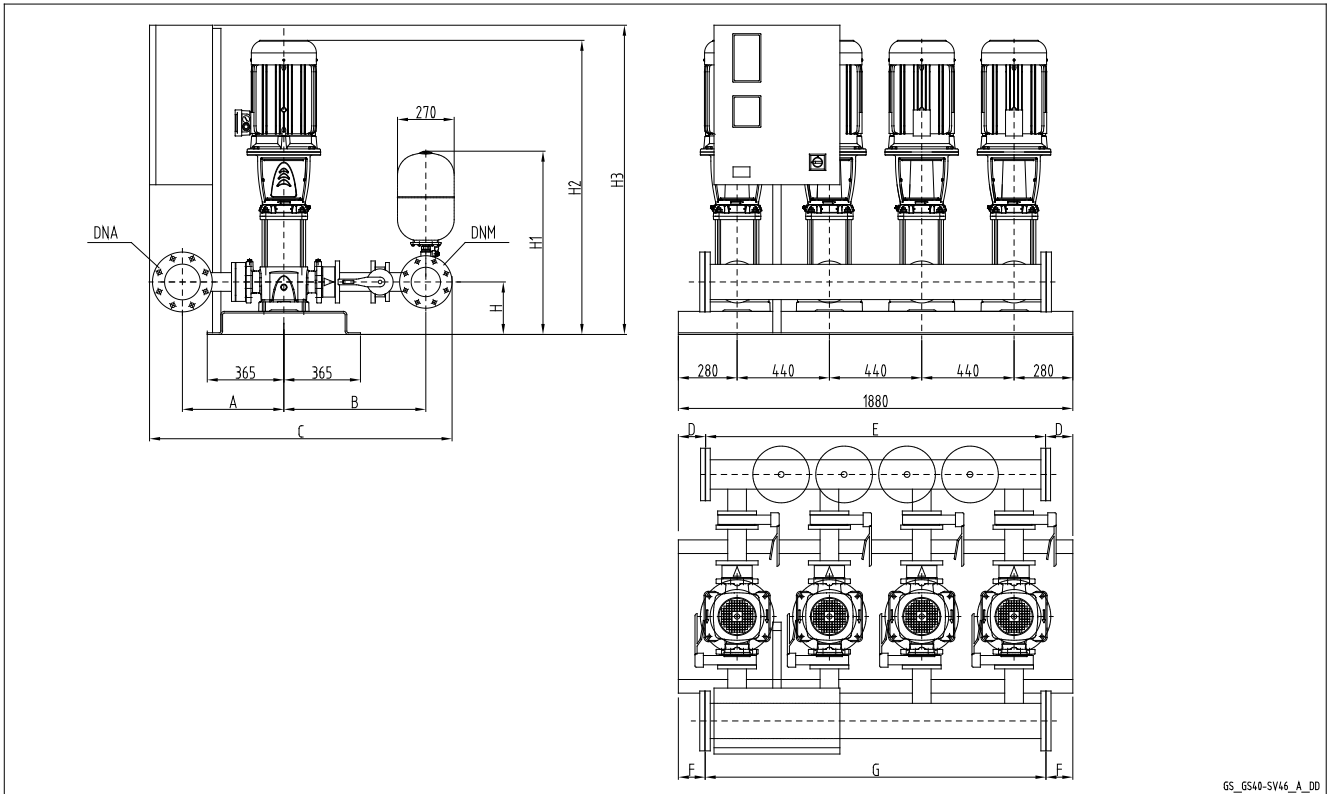

GS_6540-SV46_A_DD

**GVF13D
GVF13Y**

FOUR-PUMP BOOSTER SETS, GVF13 SERIES
VERTICAL ELECTRIC PUMPS WITH NON-RETURN VALVE ON DISCHARGE SIDE

GVF13	DNA	DNM	A	B	C	D	E	F	G	H	H1	H2	H3
33SV1/1AG022T	125	125	461	726	1451	110	1660	110	1660	215	835	897	1321
33SV1G030T	125	125	461	726	1451	110	1660	110	1660	215	835	897	1321
33SV2/2AG040T	125	125	461	726	1451	110	1660	110	1660	215	835	993	1321
33SV2/1AG040T	125	125	461	726	1451	110	1660	110	1660	215	835	993	1321
33SV2G055T	125	125	461	726	1451	110	1660	110	1660	215	835	1069	1321
33SV3/2AG055T	125	125	461	726	1451	110	1660	110	1660	215	835	1144	1321
33SV3/1AG075T	125	125	461	726	1451	110	1660	110	1660	215	835	1136	1821
33SV3G075T	125	125	461	726	1451	110	1660	110	1660	215	835	1136	1821
33SV4/2AG075T	125	125	461	726	1451	110	1660	110	1660	215	835	1211	1821
33SV4/1AG110T	125	125	461	726	1501	110	1660	110	1660	215	835	1307	1821
33SV4G110T	125	125	461	726	1501	110	1660	110	1660	215	835	1307	1821
33SV5/2AG110T	125	125	461	726	1501	110	1660	110	1660	215	835	1382	1821
33SV5/1AG110T	125	125	461	726	1501	110	1660	110	1660	215	835	1382	1821
33SV5G150T	125	125	461	726	1437	110	1660	110	1660	215	835	1448	1821
33SV6/2AG150T	125	125	461	726	1437	110	1660	110	1660	215	835	1523	1821
33SV6/1AG150T	125	125	461	726	1437	110	1660	110	1660	215	835	1523	1821
33SV6G150T	125	125	461	726	1437	110	1660	110	1660	215	835	1523	1821
33SV7/2AG150T	125	125	461	726	1437	110	1660	110	1660	215	835	1598	1821
46SV1/1AG030T	150	150	498	766	1548	90	1700	90	1700	250	884	937	1321
46SV1G040T	150	150	498	766	1548	90	1700	90	1700	250	884	958	1321
46SV2/2AG055T	150	150	498	766	1548	90	1700	90	1700	250	884	1109	1321
46SV2G075T	150	150	498	766	1548	90	1700	90	1700	250	884	1101	1821
46SV3/2AG110T	150	150	498	766	1558	90	1700	90	1700	250	884	1272	1821
46SV3G110T	150	150	498	766	1558	90	1700	90	1700	250	884	1272	1821
46SV4/2AG150T	150	150	498	766	1548	90	1700	90	1700	250	884	1413	1821
46SV4G150T	150	150	498	766	1548	90	1700	90	1700	250	884	1413	1821
66SV1/1AG040T	200	200	529	819	1688	90	1700	90	1700	250	910	983	1321
66SV1G055T	200	200	529	819	1688	90	1700	90	1700	250	910	1059	1321
66SV2/2AG075T	200	200	529	819	1688	90	1700	90	1700	250	910	1141	1821
66SV2/1AG110T	200	200	529	819	1688	90	1700	90	1700	250	910	1237	1821
66SV2G110T	200	200	529	819	1688	90	1700	90	1700	250	910	1237	1821
66SV3/2AG150T	200	200	529	819	1688	90	1700	90	1700	250	910	1393	1821
66SV3/1AG150T	200	200	529	819	1688	90	1700	90	1700	250	910	1393	1821
92SV1/1AG055T	250	200	556	819	1748	90	1700	60	1760	250	910	1059	1321
92SV1G075T	250	200	556	819	1748	90	1700	60	1760	250	910	1051	1821
92SV2/2AG110T	250	200	556	819	1748	90	1700	60	1760	250	910	1237	1821
92SV2G150T	250	200	556	819	1748	90	1700	60	1760	250	910	1303	1821

Dimensions in mm. Tolerance ± 10 mm.

Note: for version with vibration damping, feet increase height by 50mm

gvf13_sv46_b_td

GVF13D
GVF13Y

FOUR-PUMP BOOSTER SETS, GVF13 SERIES
VERTICAL ELECTRIC PUMPS WITH NON-RETURN VALVE ON DISCHARGE SIDE

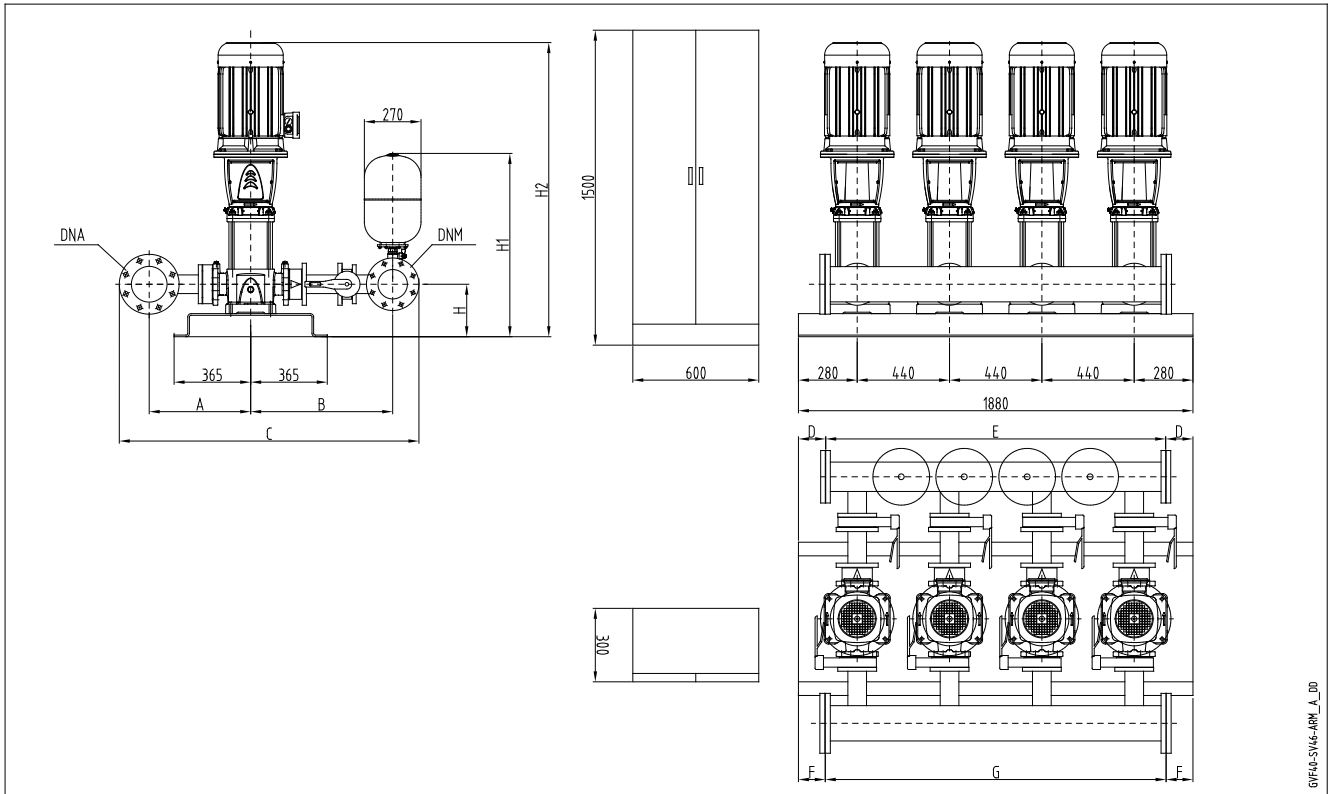

GVF13-SV46-ARM_A_ID

GVF13D
GVF13Y

GVF13	DNA	DNM	A	B	C	D	E	F	G	H	H1	H2
46SV5/2AG185T	150	150	498	766	1548	90	1700	90	1700	250	884	1488
46SV5G185T	150	150	498	766	1548	90	1700	90	1700	250	884	1488
46SV6/2AG220T	150	150	498	766	1548	90	1700	90	1700	250	884	1563
46SV6G220T	150	150	498	766	1548	90	1700	90	1700	250	884	1563
66SV3G185T	200	200	529	819	1688	90	1700	90	1700	250	910	1393
66SV4/2AG185T	200	200	529	819	1688	90	1700	90	1700	250	910	1483
66SV4/1AG220T	200	200	529	819	1688	90	1700	90	1700	250	910	1483
66SV4G220T	200	200	529	819	1688	90	1700	90	1700	250	910	1483
92SV3/2AG185T	250	200	556	819	1748	90	1700	60	1760	250	910	1393
92SV3G220T	250	200	556	819	1748	90	1700	60	1760	250	910	1393

Dimensions in mm. Tolerance ± 10 mm.

Note: for version with vibration damping, feet increase height by 50mm

gvf13_sv46-arm_a_id

FOUR-PUMP BOOSTER SETS, GVF13 SERIES
VERTICAL ELECTRIC PUMPS WITH NON-RETURN VALVE ON DISCHARGE SIDE

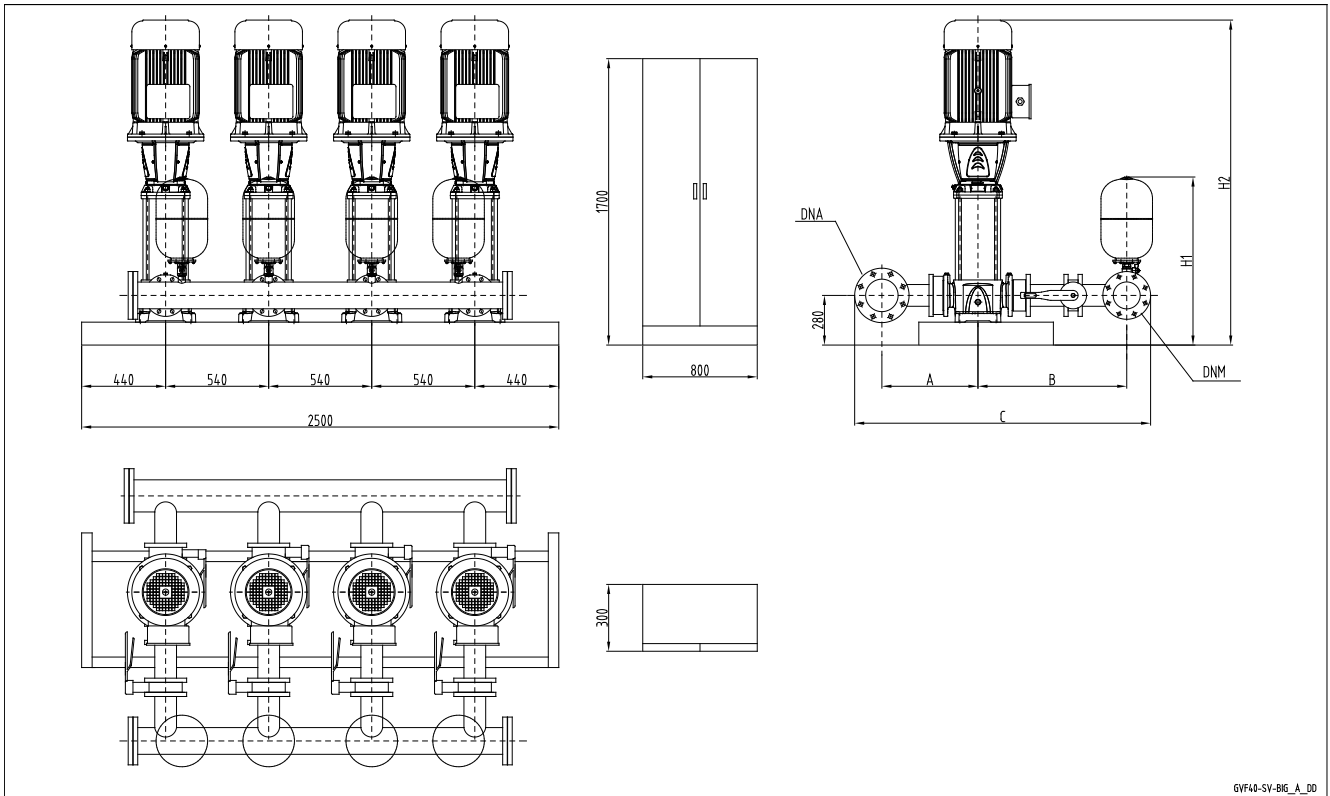

GVF40-SV-BIG_A_00

GVF13D
GVF13Y

GVF13	DNA	DNM	A	B	C	H1	H2
66SV5/2AG300T	200	200	529	819	1635	914	1766
66SV5/1AG300T	200	200	529	819	1635	914	1766
66SV5G300T	200	200	529	819	1635	914	1766
92SV4/2AG300T	250	200	556	819	1688	940	1676
92SV4G300T	250	200	556	819	1688	940	1676
92SV5/2AG370T	250	200	556	819	1688	940	1766

Dimensions in mm. Tolerance ± 10 mm.

Note: for version with vibration damping, feet increase height by 50mm

gvf13_sv-big_b_td

FOUR-PUMP BOOSTER SETS, GVF13 SERIES
VERTICAL ELECTRIC PUMPS WITH NON-RETURN VALVE ON DISCHARGE SIDE

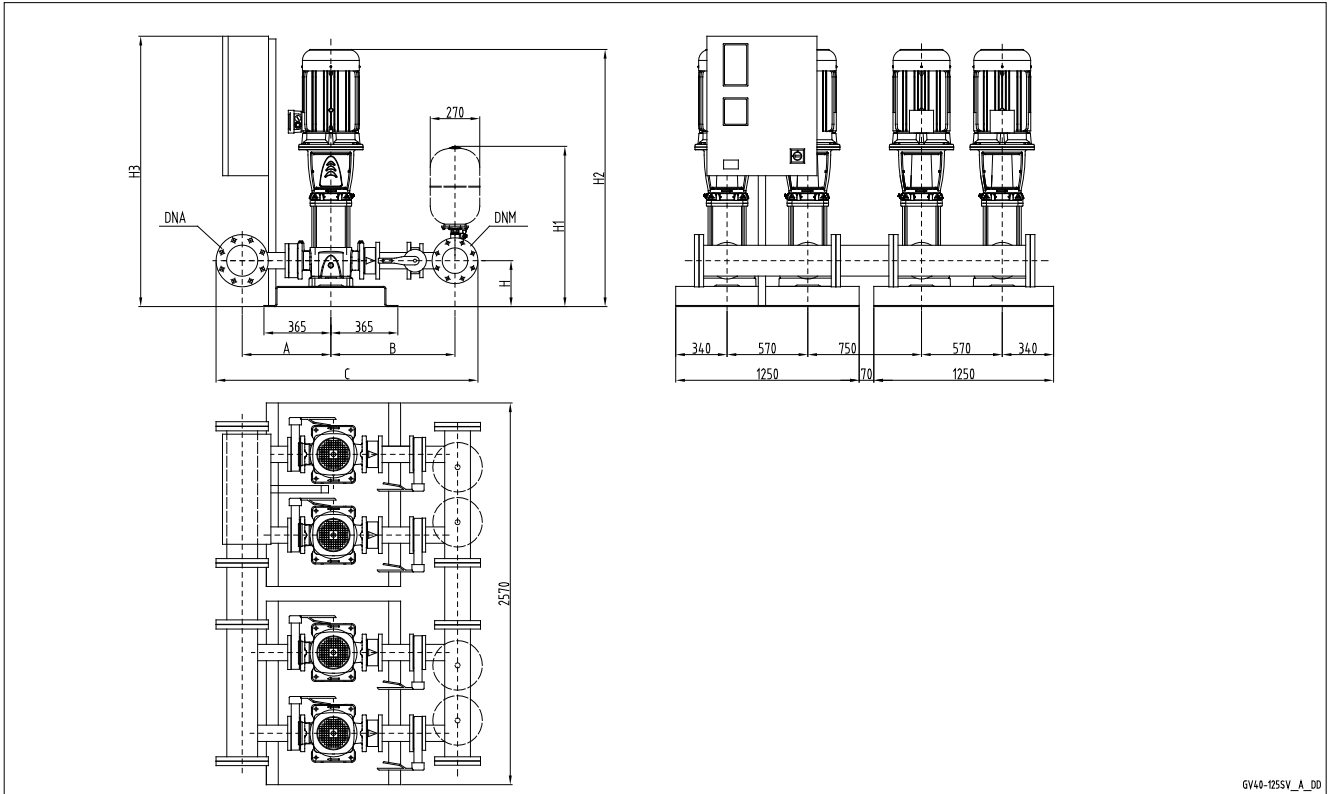

GV40-125SV_A_DD

GVF13D
GVF13Y

GVF13	DNA	DNM	A	B	C	H	H1	H2	H3
125SV1G075T	300	250	643	954	2029	280	967	1180	1822
125SV2G150T	300	250	643	954	2029	280	967	1492	1822

Dimensions in mm. Tolerance ± 10 mm.
Note: for version with vibration damping, feet increase height by 50mm

gvf13_125sv_a_td

FOUR-PUMP BOOSTER SETS, GVF13 SERIES
VERTICAL ELECTRIC PUMPS WITH NON-RETURN VALVE ON DISCHARGE SIDE

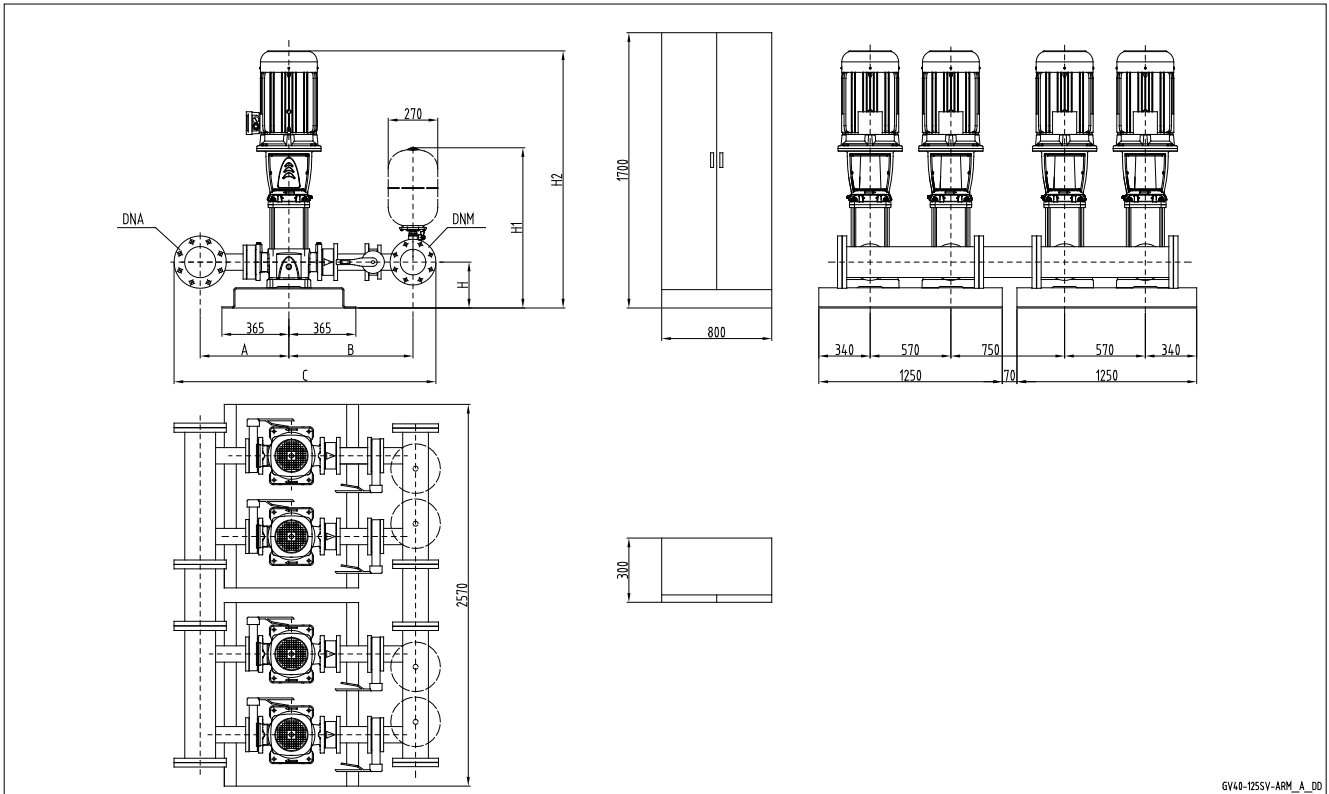

GV40-125SV-ARM_A_DD

GVF13D
GVF13Y

GVF13	DNA	DNM	A	B	C	H	H1	H2
125SV3G220T	300	250	643	954	2029	280	967	1642

Dimensions in mm. Tolerance ± 10 mm.

Note: for version with vibration damping, feet increase height by 50mm

gvf13_125sv-arm_a_td

**FOUR-PUMP BOOSTER SETS, GVF13 SERIES
VERTICAL ELECTRIC PUMPS WITH NON-RETURN VALVE ON DISCHARGE SIDE**

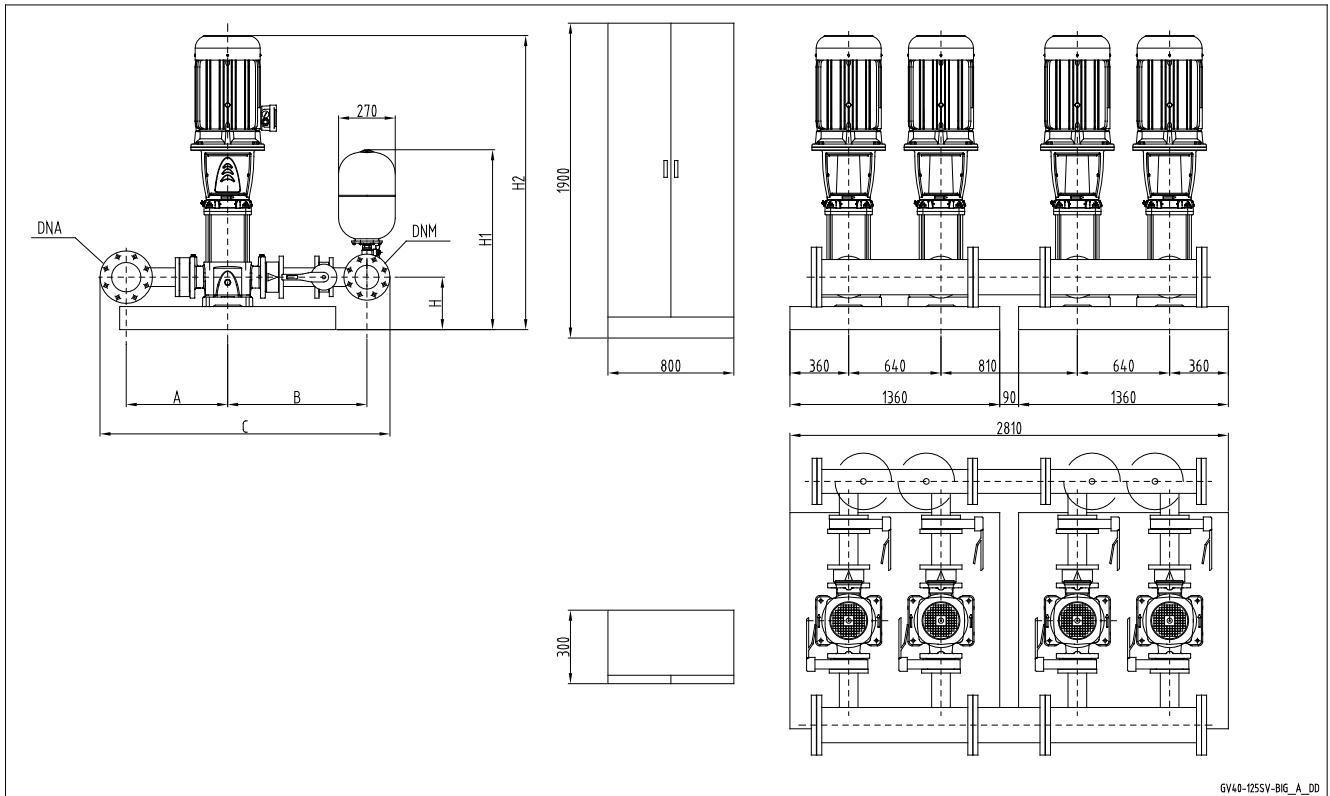

**GVF13D
GVF13Y**

GVF13	DNA	DNM	A	B	C	H	H1	H2
125SV4G300T	300	250	643	954	2029	300	987	1975
125SV5G370T	300	250	643	954	2029	300	987	2125

Dimensions in mm. Tolerance ± 10 mm.
Note: for version with vibration damping, feet increase height by 50mm

gvf13_125sv-big_a_td

PERFORMANCES CURVES

BOOSTER SETS, GVF.../SV SERIES OPERATING CHARACTERISTICS

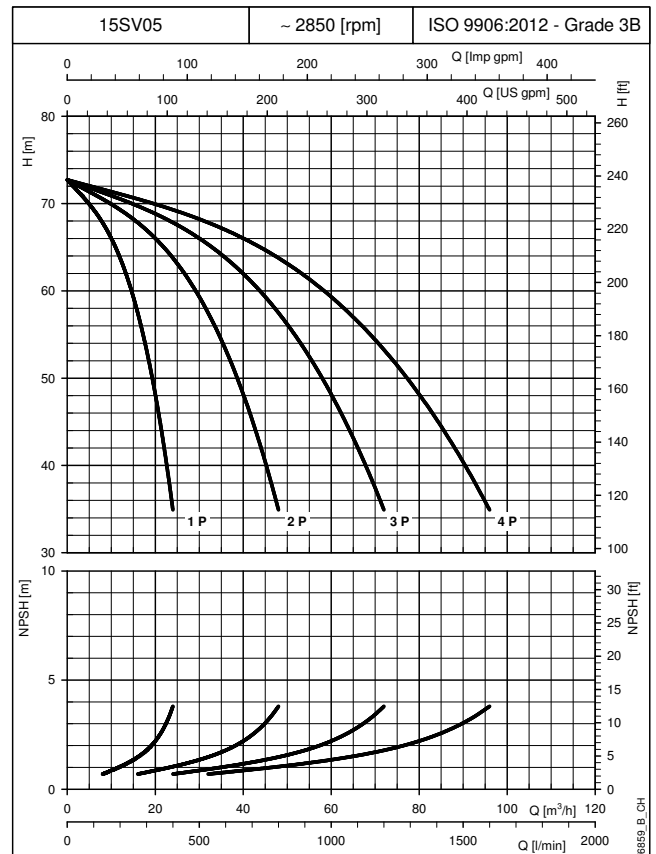
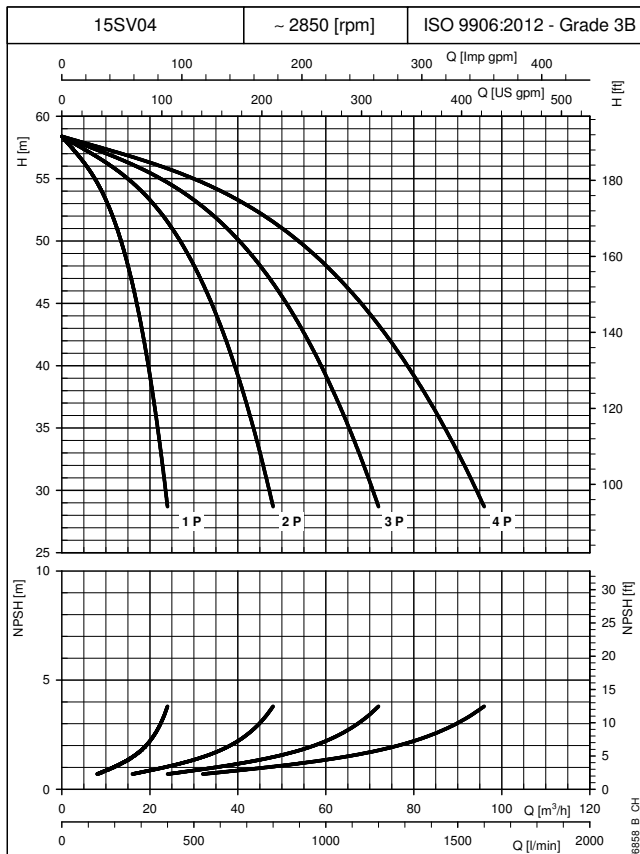
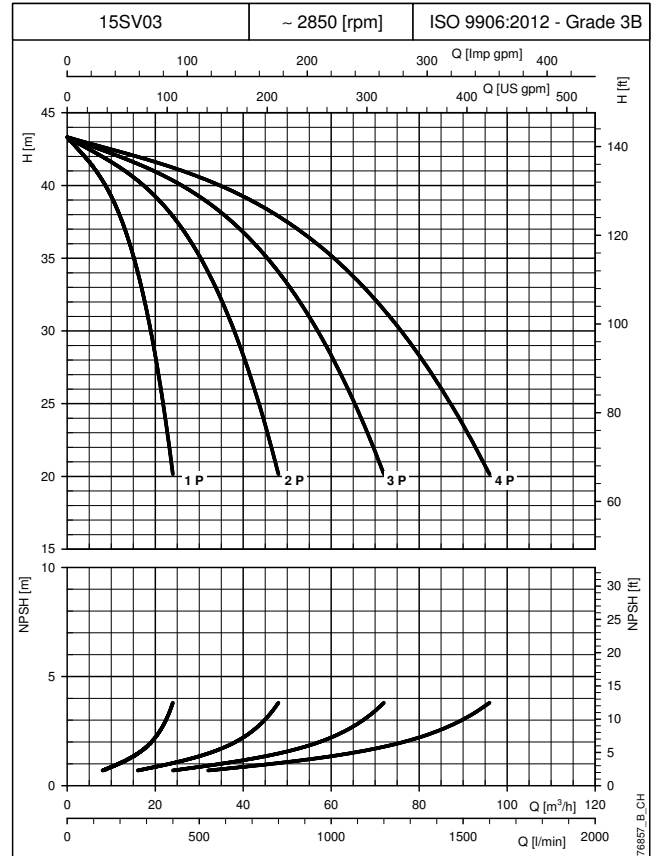
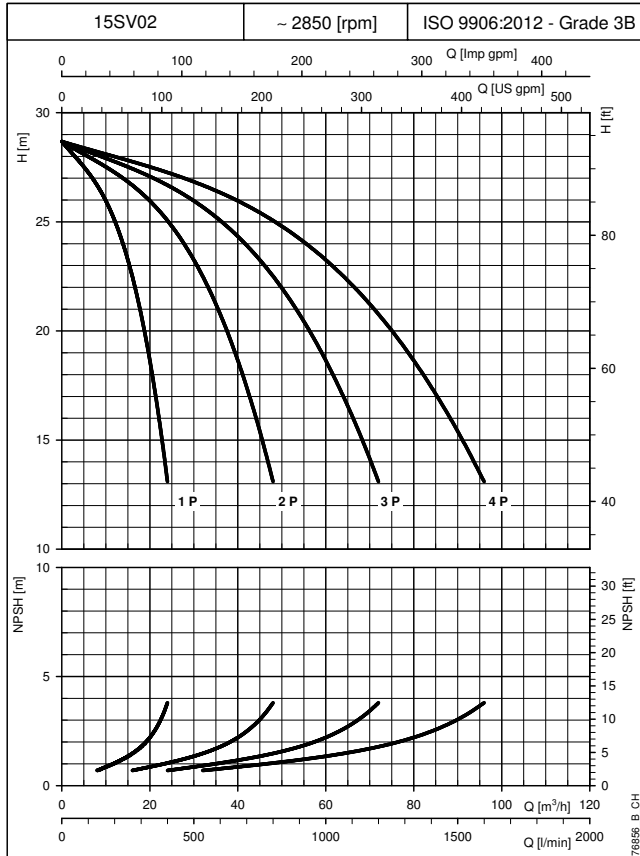

CURVE

The performance CURVES do not take into account flow resistance in the valves and piping.
 The CURVE show the performance with one and two pumps running.
 These performances are valid for liquids with density $\rho = 1.0 \text{ Kg/dm}^3$ and kinematic viscosity $\nu = 1 \text{ mm}^2/\text{s}$.
 The declared NPSH values are laboratory values: for practical use we recommend increasing these values by 0,5 m.

BOOSTER SETS, GVF.../SV SERIES OPERATING CHARACTERISTICS

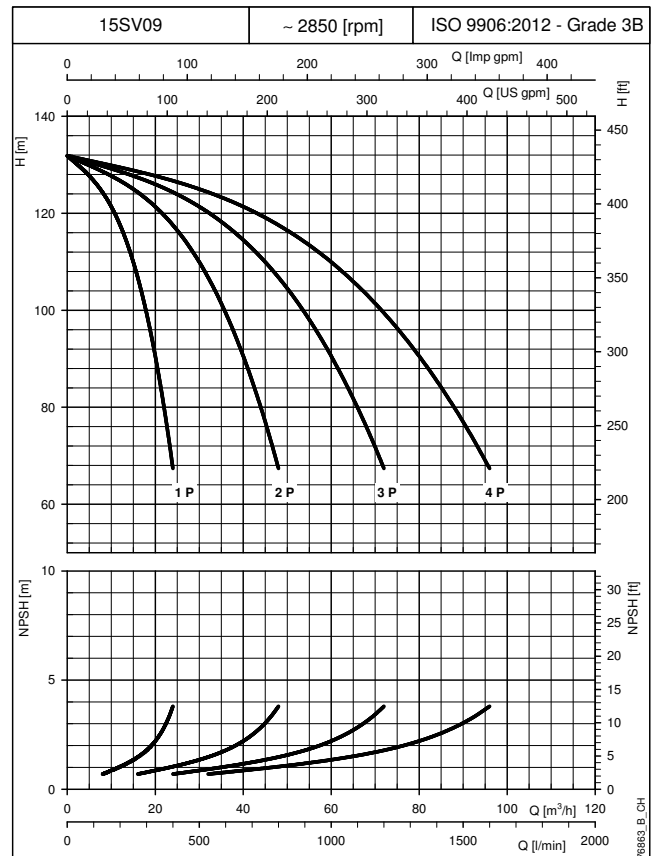
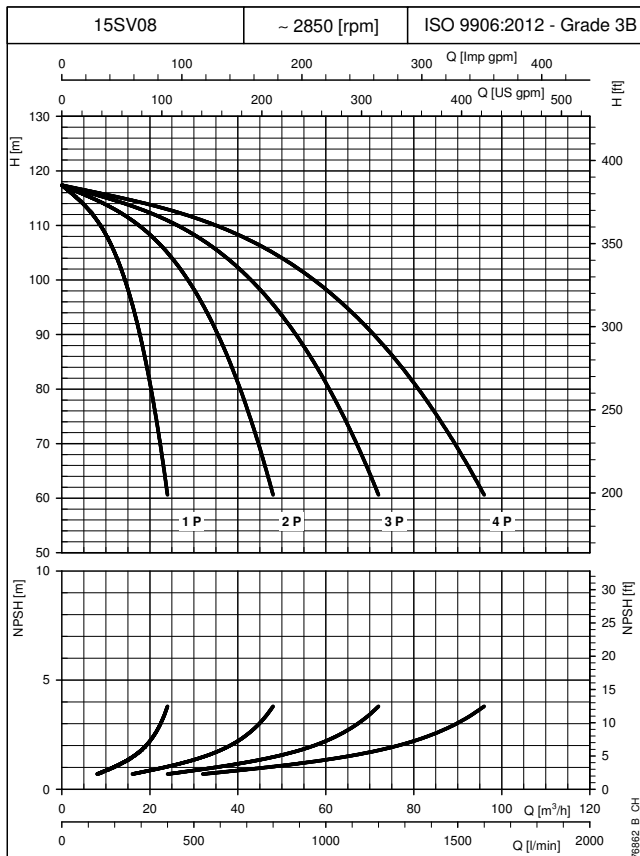
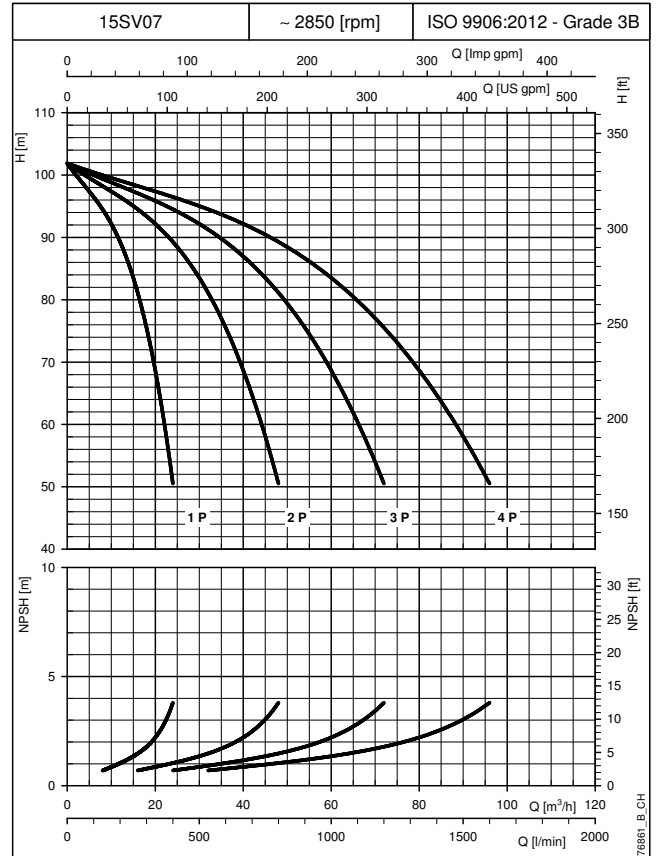
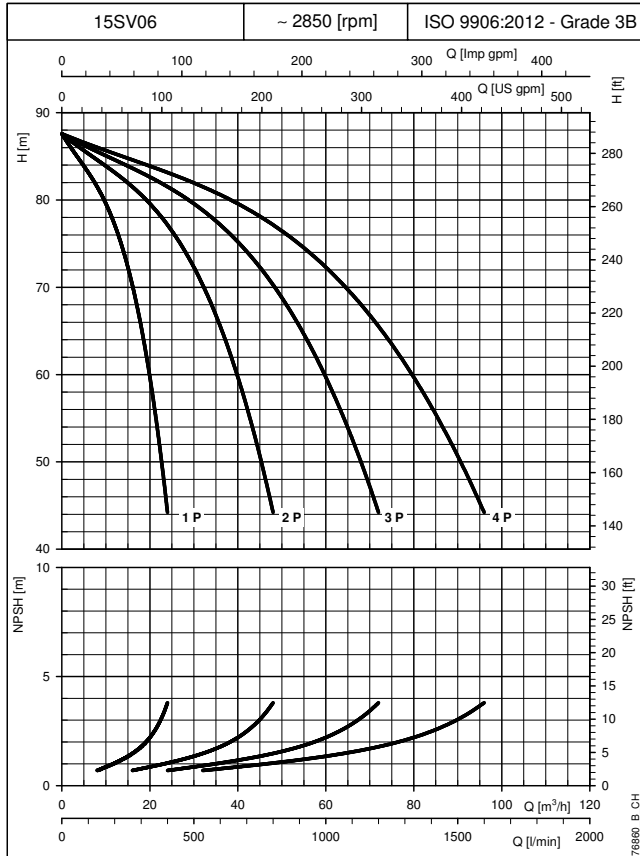

The performance curves do not take into account flow resistance in the valves and piping.
 The curves show the performance with one and two pumps running.
 These performances are valid for liquids with density $\rho = 1.0 \text{ Kg/dm}^3$ and kinematic viscosity $\nu = 1 \text{ mm}^2/\text{s}$.
 The declared NPSH values are laboratory values: for practical use we recommend increasing these values by 0,5 m.

CURVE

BOOSTER SETS, GVF.../SV SERIES OPERATING CHARACTERISTICS

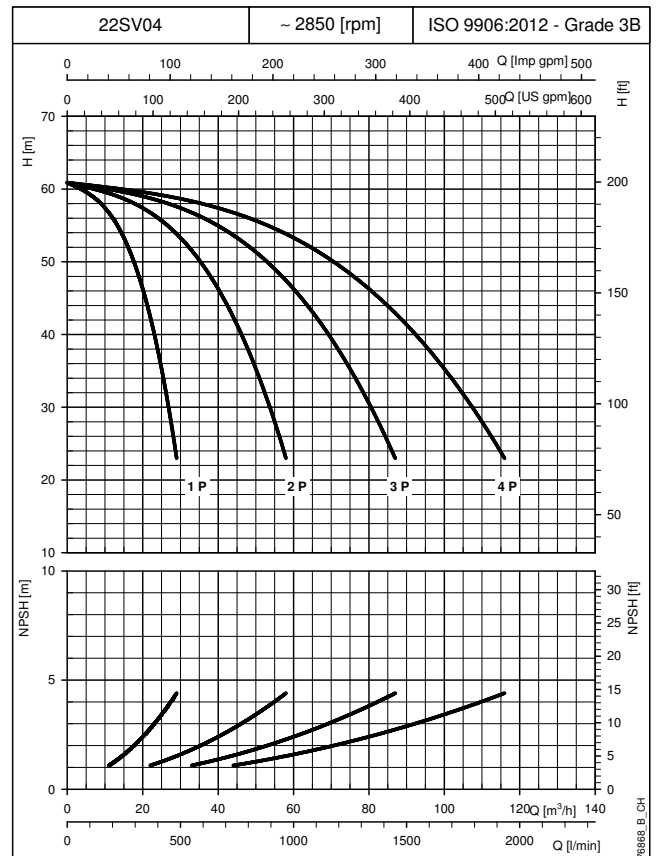
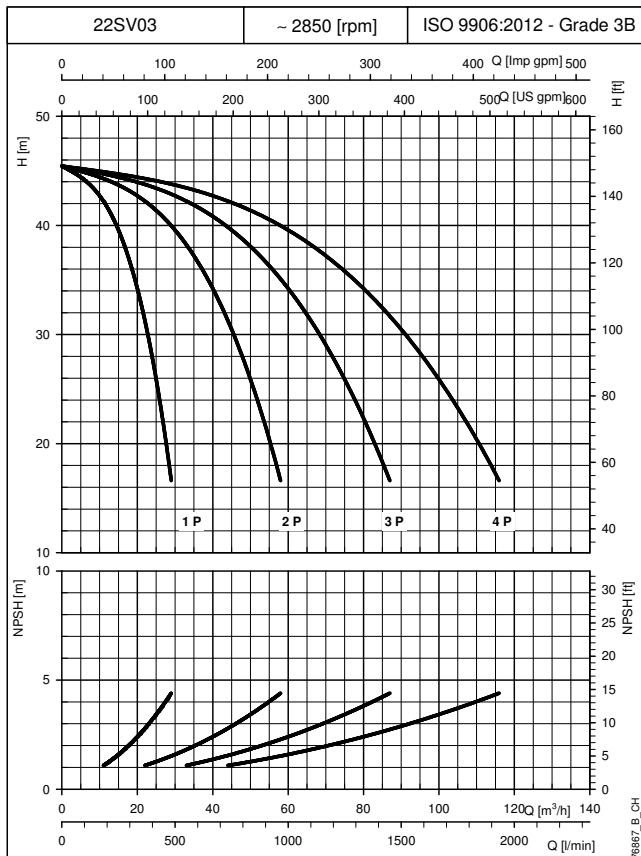
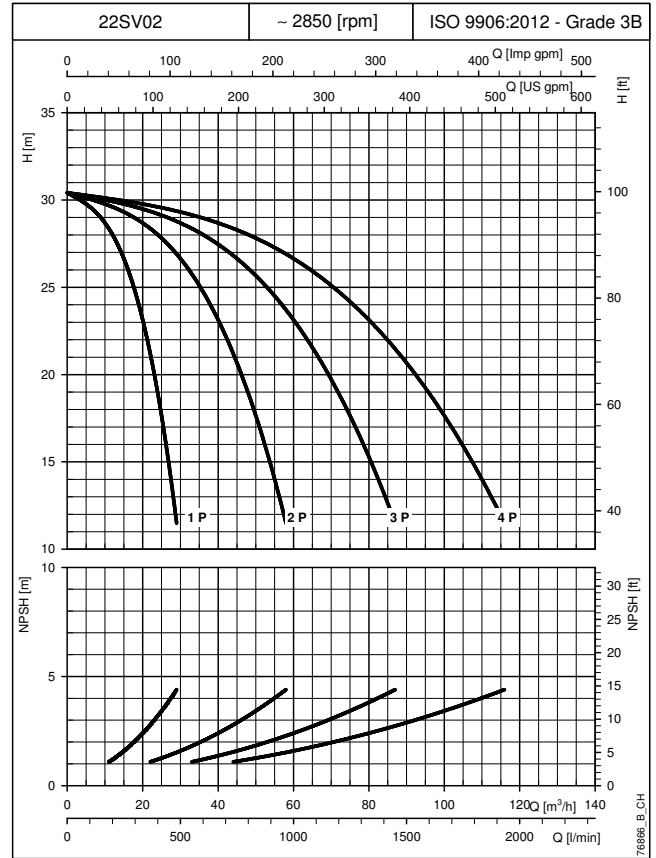
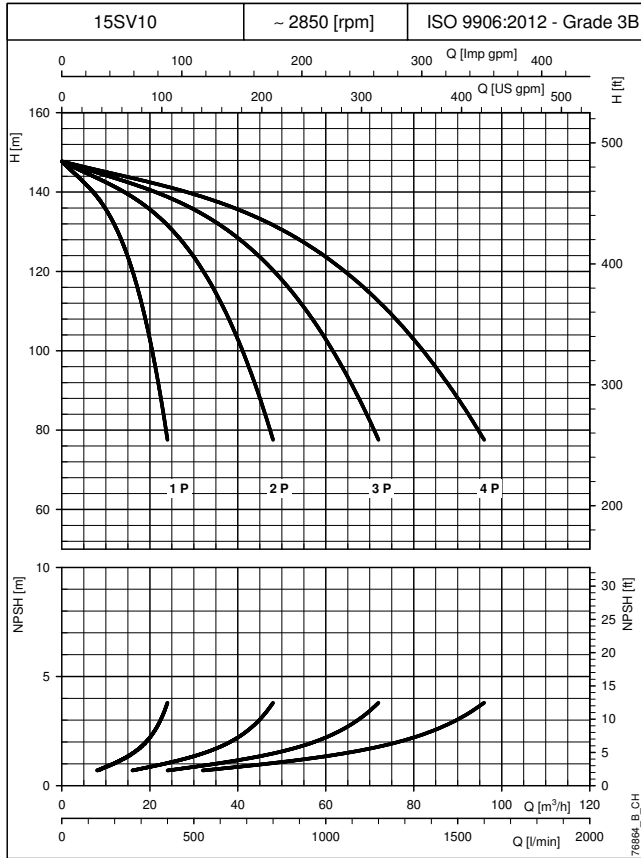

CURVE

The performance curves do not take into account flow resistance in the valves and piping.
The curves show the performance with one and two pumps running.
These performances are valid for liquids with density $\rho = 1.0 \text{ Kg/dm}^3$ and kinematic viscosity $\nu = 1 \text{ mm}^2/\text{s}$.
The declared NPSH values are laboratory values: for practical use we recommend increasing these values by 0,5 m.

BOOSTER SETS, GVF.../SV SERIES OPERATING CHARACTERISTICS

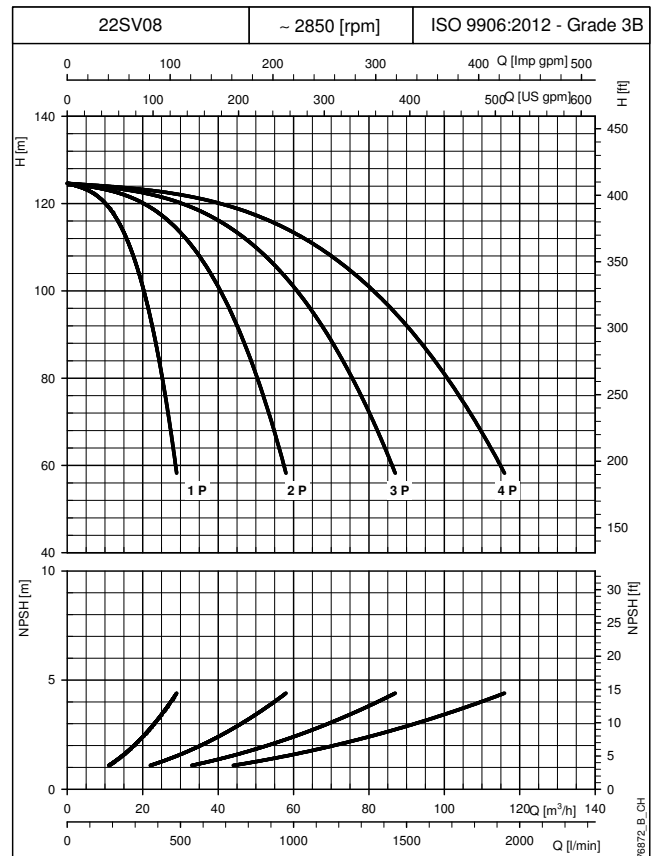
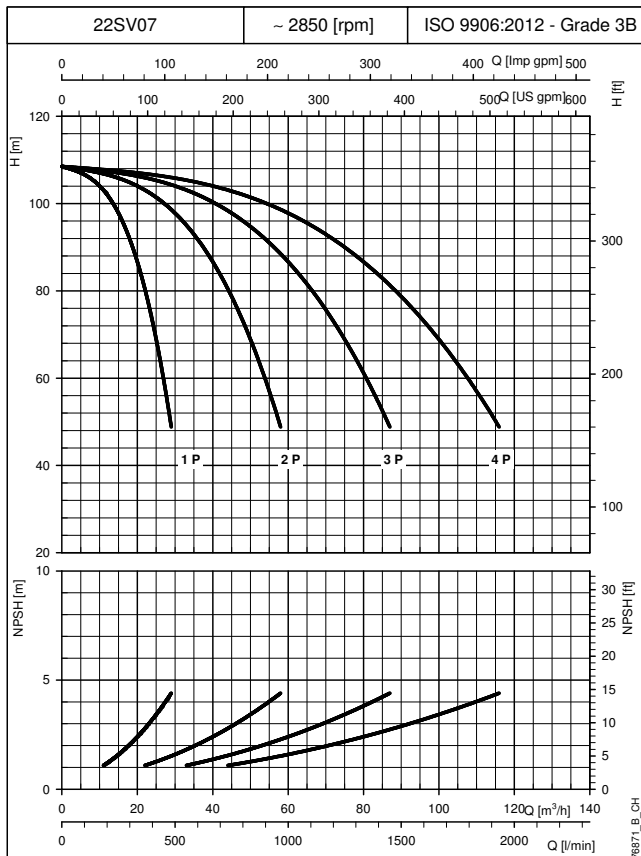
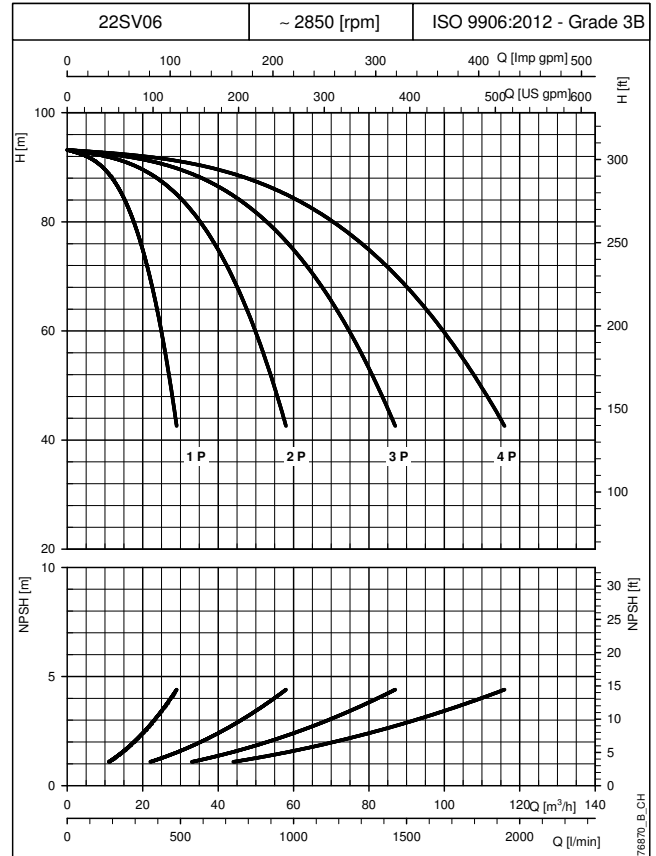
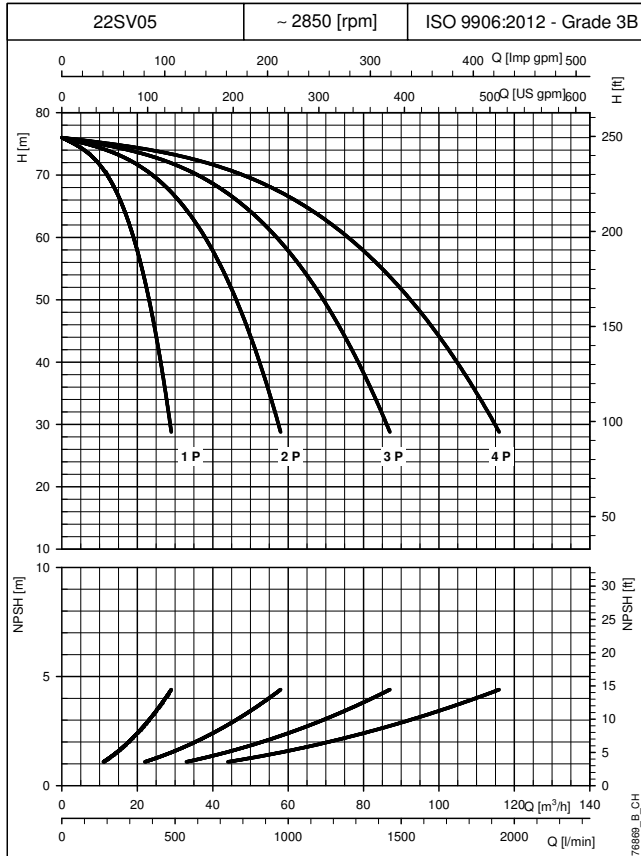

The performance curves do not take into account flow resistance in the valves and piping.
 The curves show the performance with one and two pumps running.
 These performances are valid for liquids with density $\rho = 1.0 \text{ Kg/dm}^3$ and kinematic viscosity $\nu = 1 \text{ mm}^2/\text{s}$.
 The declared NPSH values are laboratory values: for practical use we recommend increasing these values by 0,5 m.

CURVE

BOOSTER SETS, GVF.../SV SERIES OPERATING CHARACTERISTICS

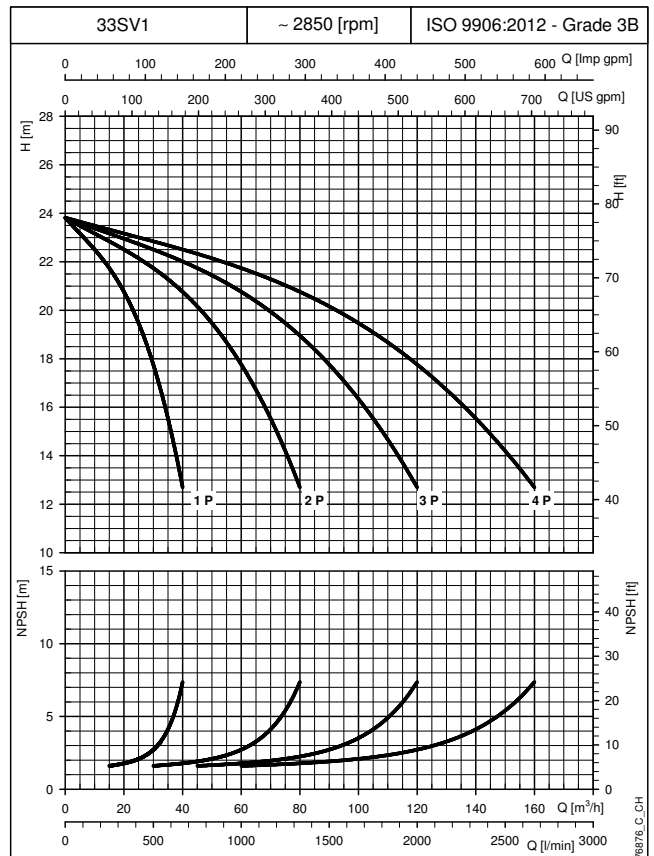
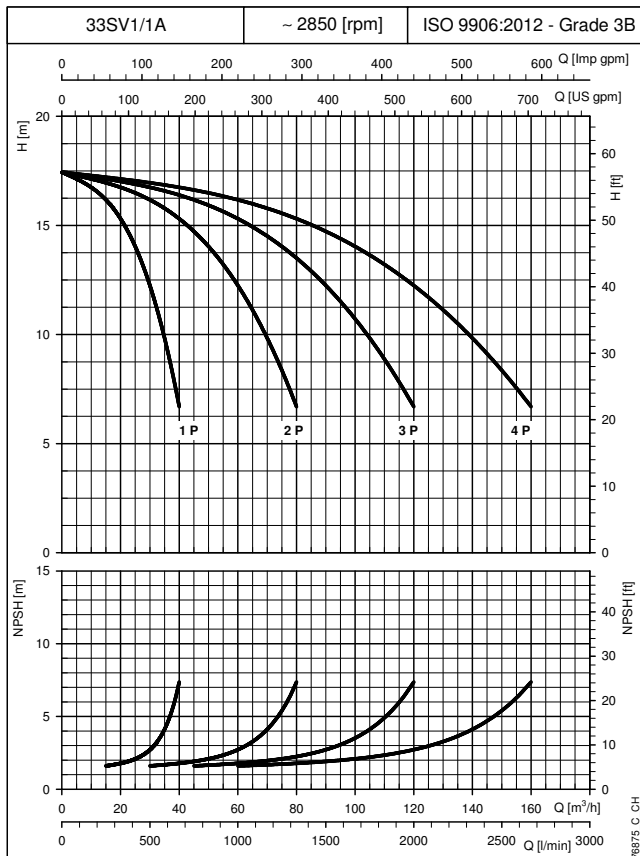
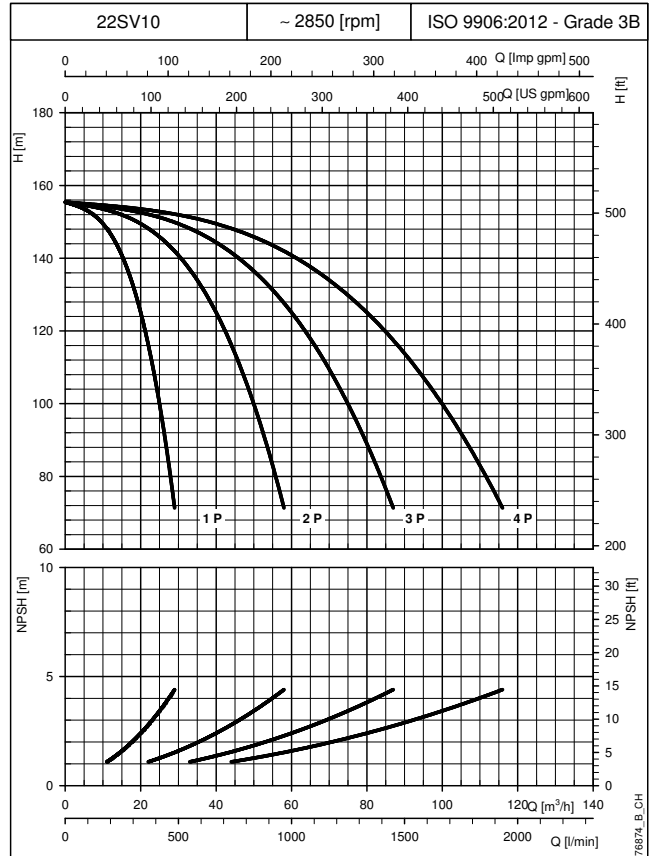
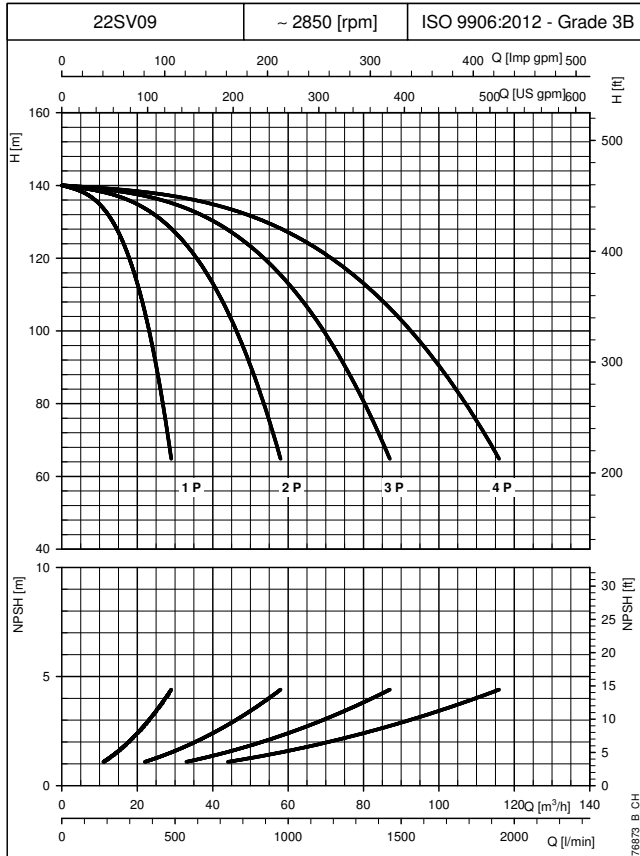

CURVE

The performance curves do not take into account flow resistance in the valves and piping.
 The curves show the performance with one and two pumps running.
 These performances are valid for liquids with density $\rho = 1.0 \text{ Kg/dm}^3$ and kinematic viscosity $\nu = 1 \text{ mm}^2/\text{s}$.
 The declared NPSH values are laboratory values: for practical use we recommend increasing these values by 0,5 m.

BOOSTER SETS, GVF.../SV SERIES OPERATING CHARACTERISTICS

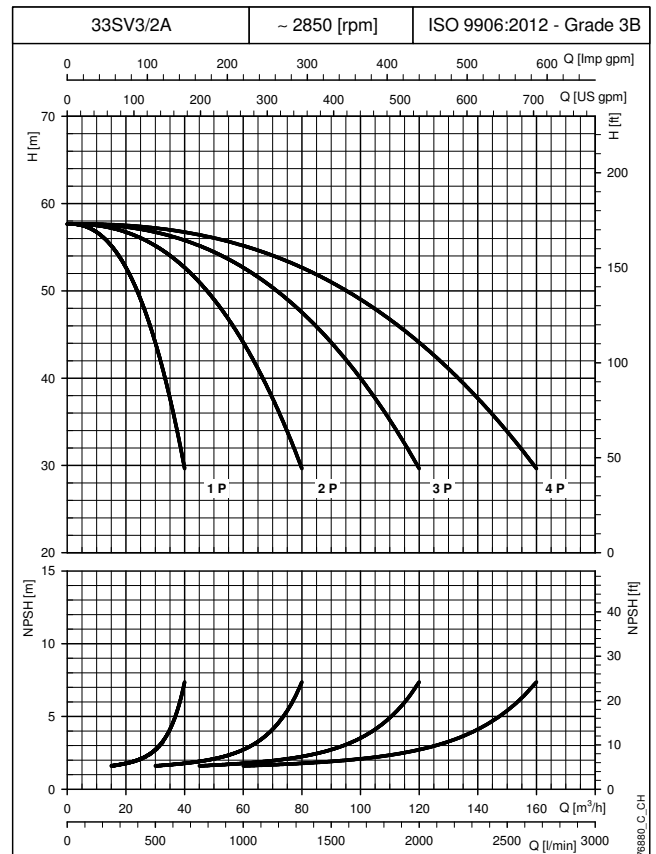
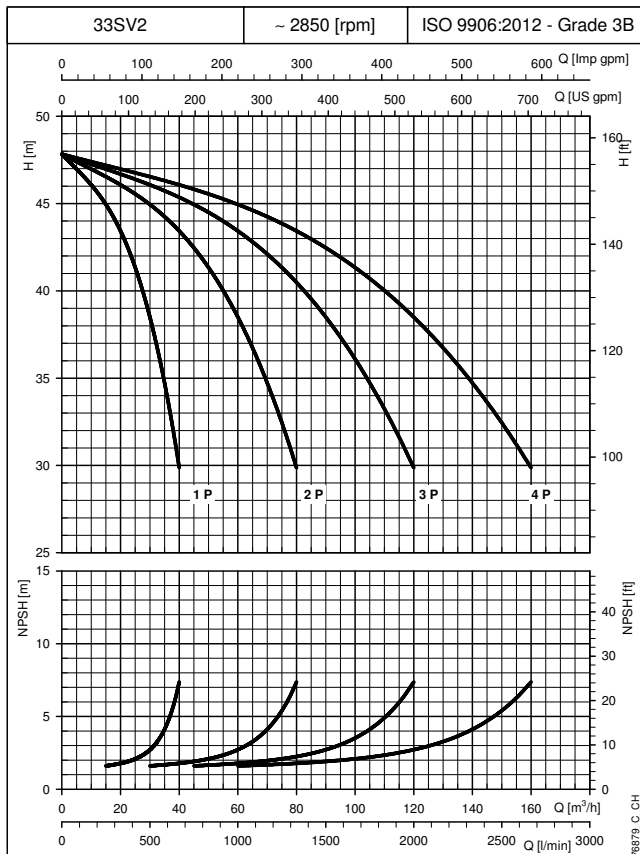
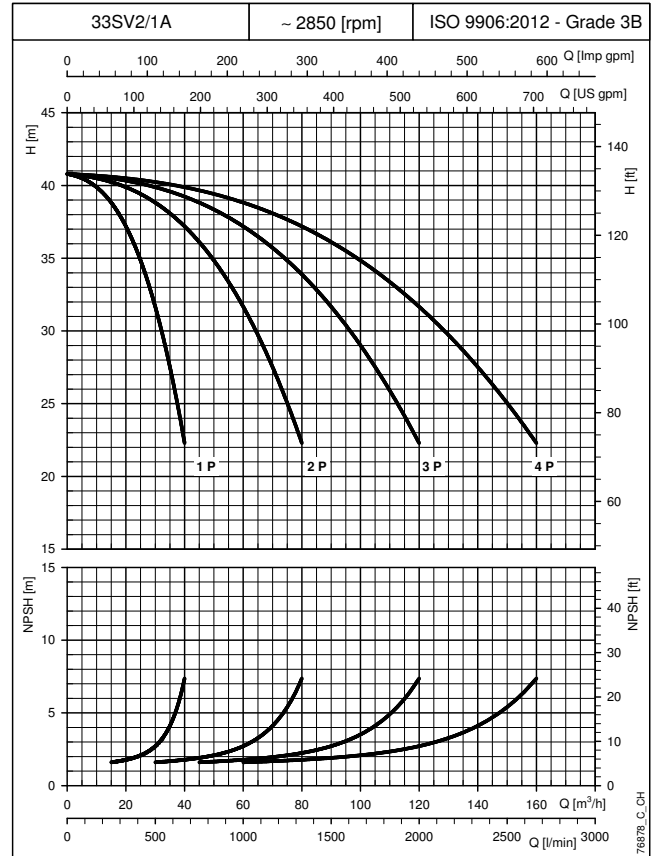
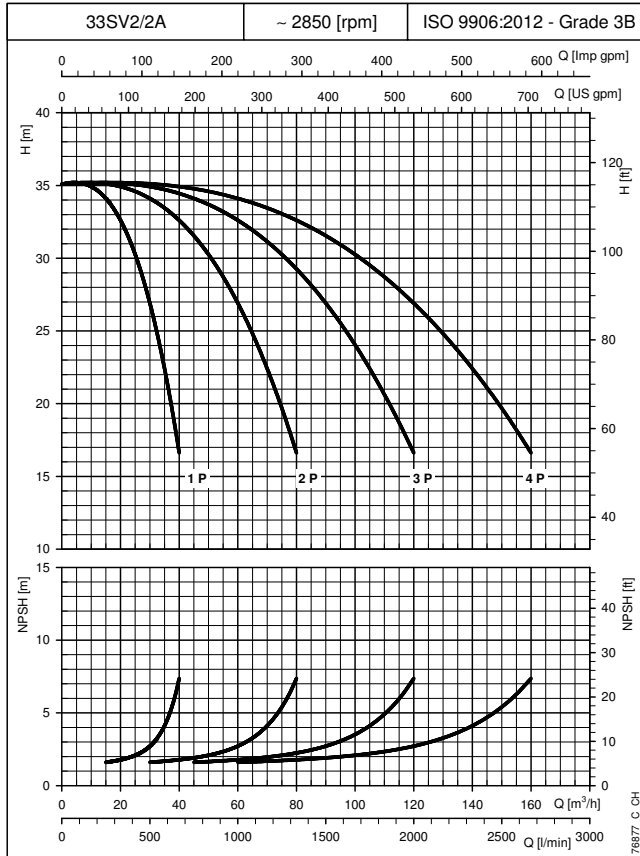

The performance curves do not take into account flow resistance in the valves and piping.
 The curves show the performance with one and two pumps running.
 These performances are valid for liquids with density $\rho = 1.0 \text{ Kg/dm}^3$ and kinematic viscosity $\nu = 1 \text{ mm}^2/\text{s}$.
 The declared NPSH values are laboratory values: for practical use we recommend increasing these values by 0,5 m.

CURVE

BOOSTER SETS, GVF.../SV SERIES OPERATING CHARACTERISTICS

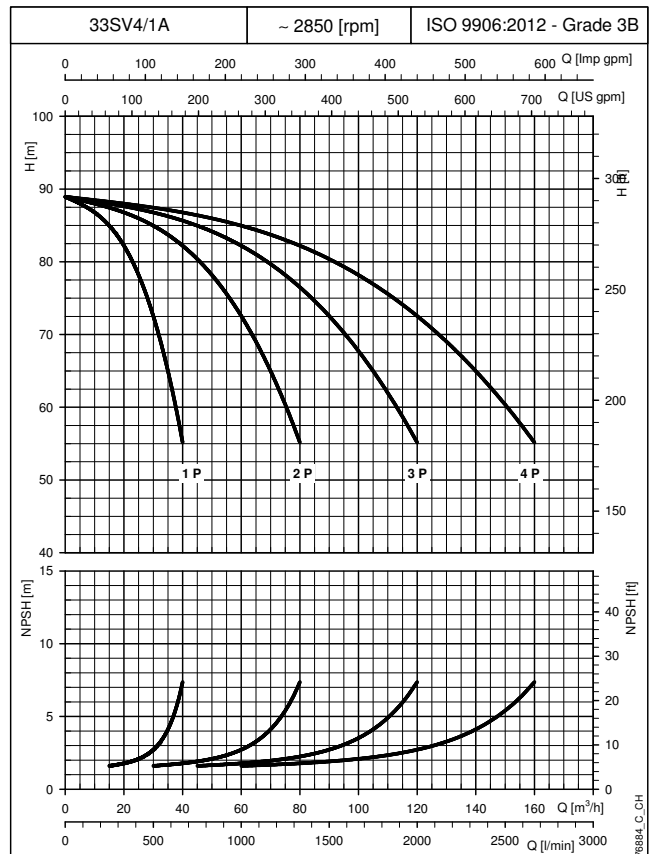
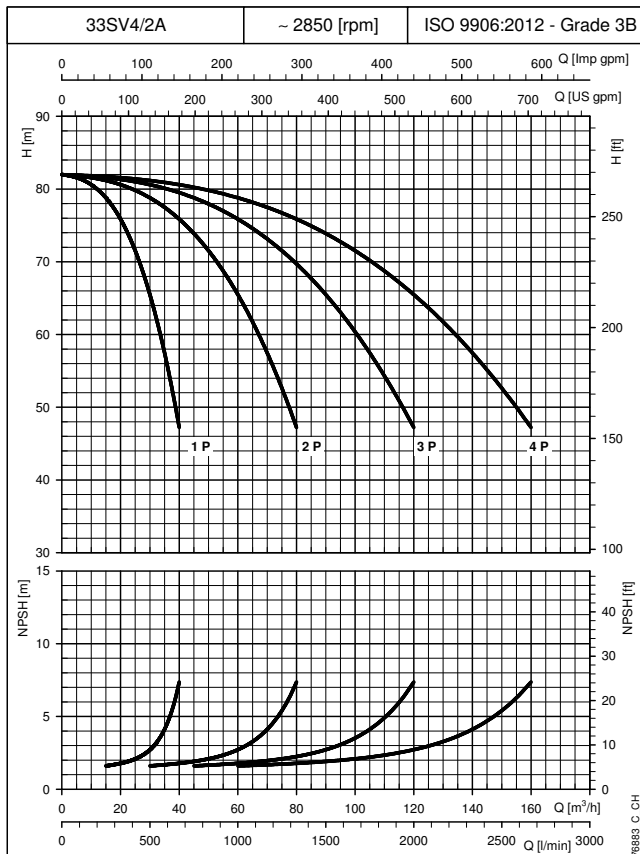
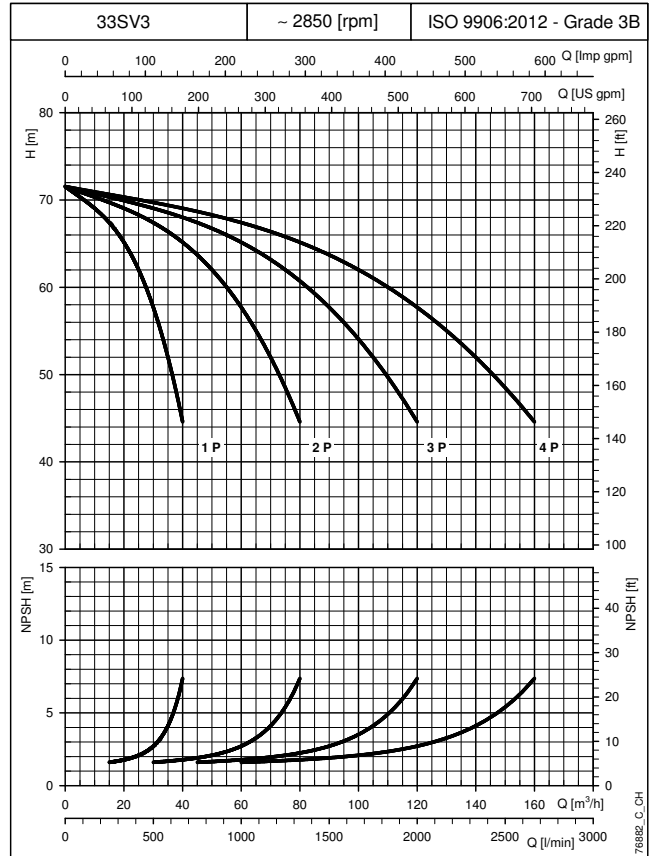
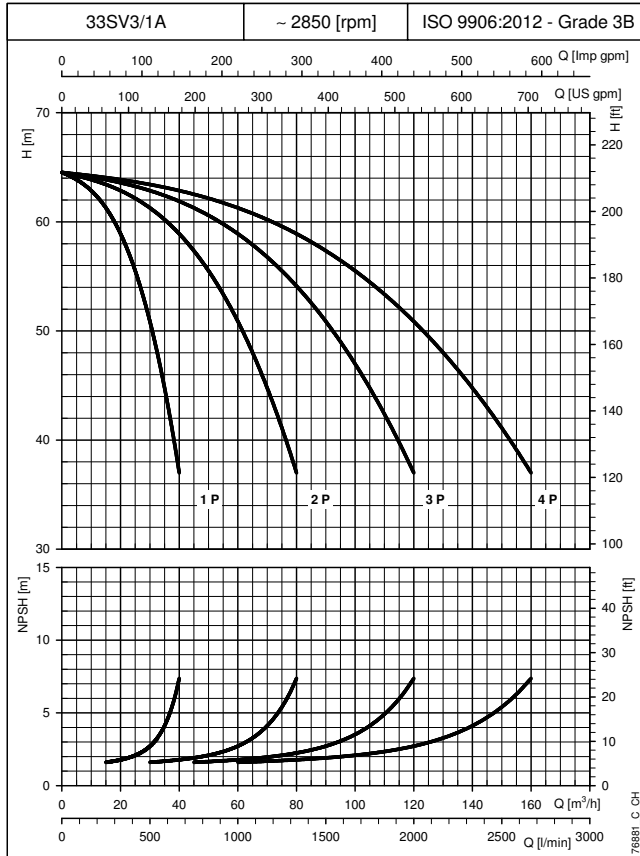

CURVE

The performance curves do not take into account flow resistance in the valves and piping.
 The curves show the performance with one and two pumps running.
 These performances are valid for liquids with density $\rho = 1.0 \text{ Kg/dm}^3$ and kinematic viscosity $\nu = 1 \text{ mm}^2/\text{s}$.
 The declared NPSH values are laboratory values: for practical use we recommend increasing these values by 0,5 m.

BOOSTER SETS, GVF.../SV SERIES OPERATING CHARACTERISTICS

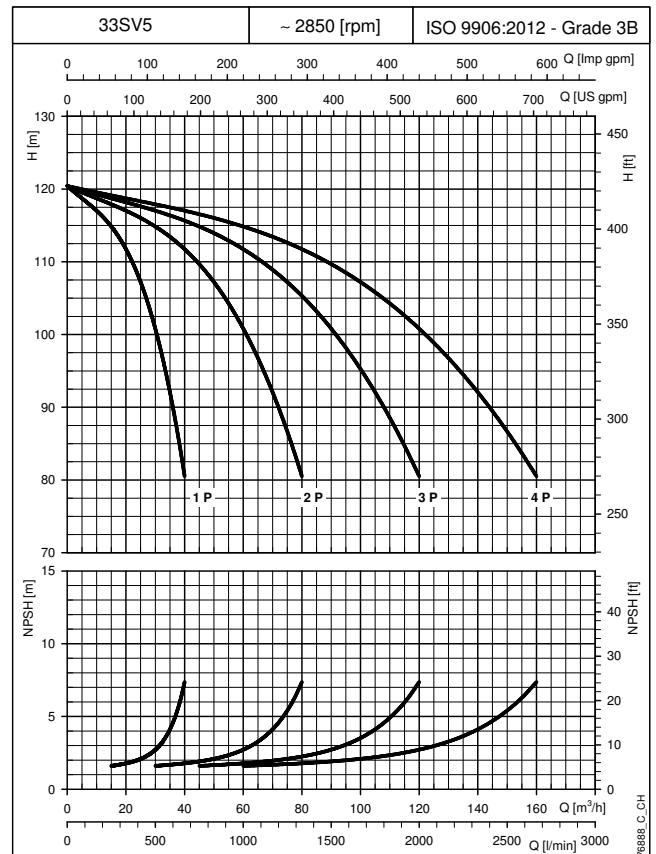
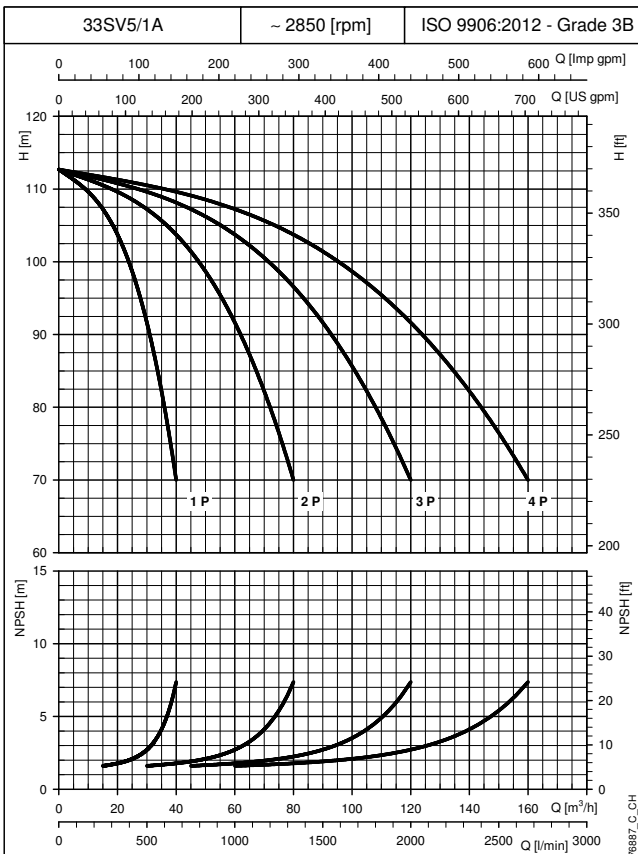
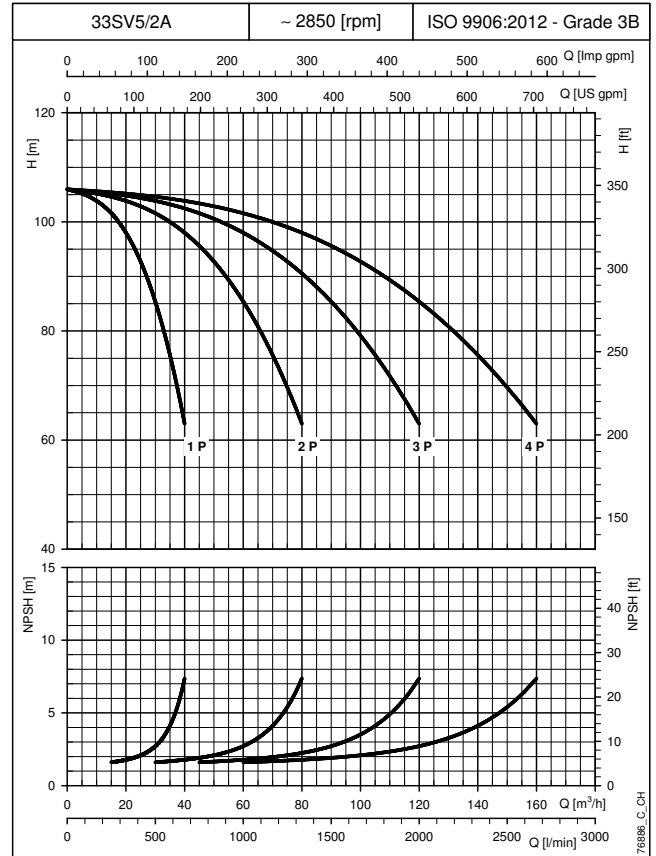
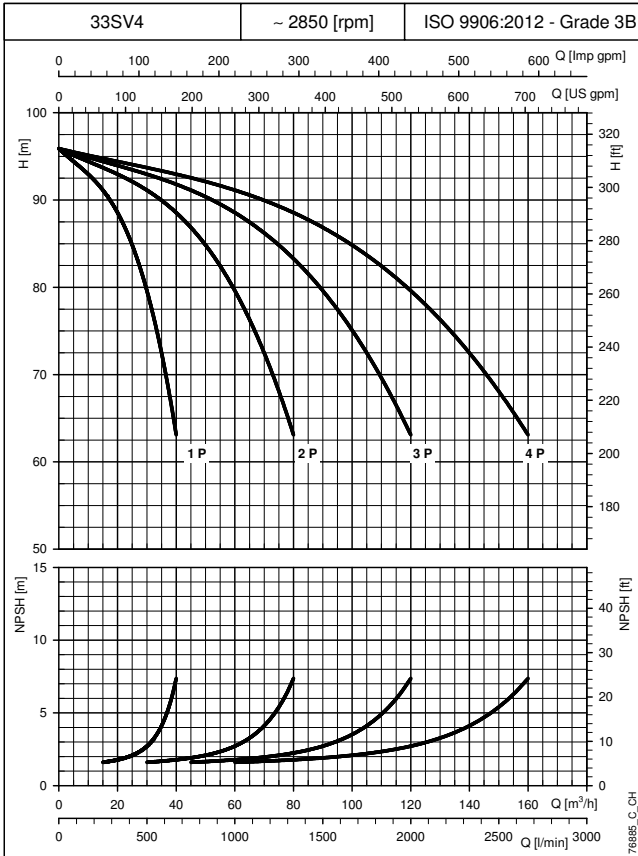

The performance curves do not take into account flow resistance in the valves and piping.
 The curves show the performance with one and two pumps running.
 These performances are valid for liquids with density $\rho = 1.0 \text{ Kg/dm}^3$ and kinematic viscosity $\nu = 1 \text{ mm}^2/\text{s}$.
 The declared NPSH values are laboratory values: for practical use we recommend increasing these values by 0,5 m.

CURVE

BOOSTER SETS, GVF.../SV SERIES OPERATING CHARACTERISTICS

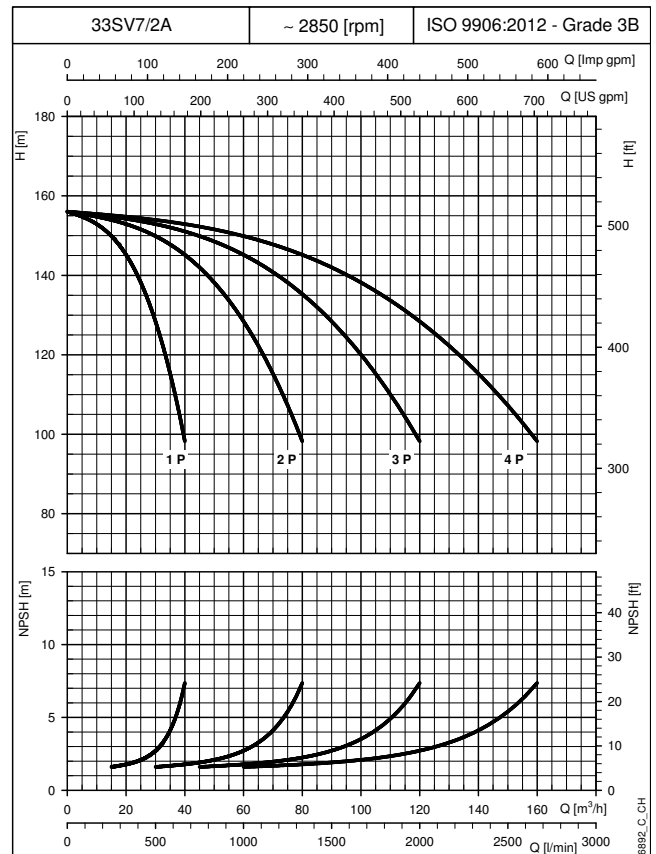
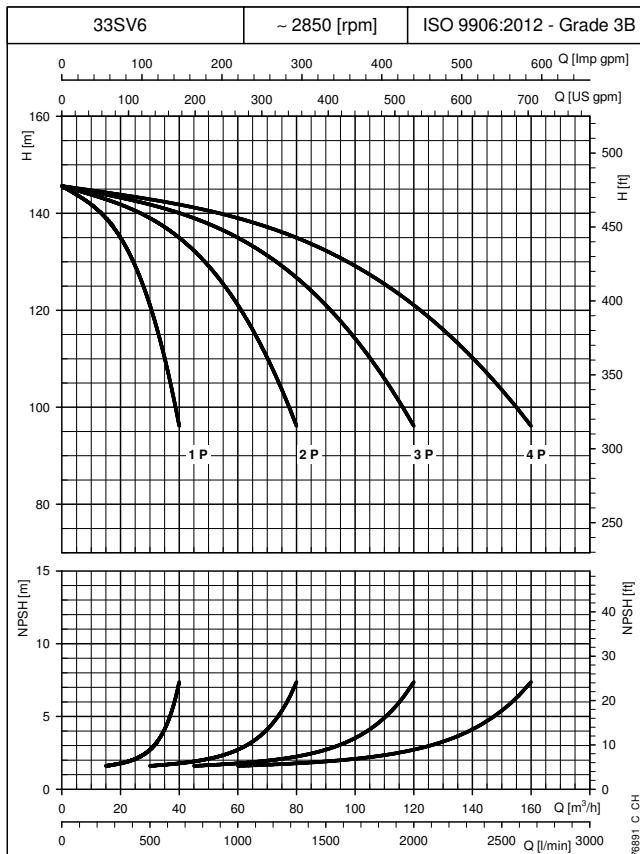
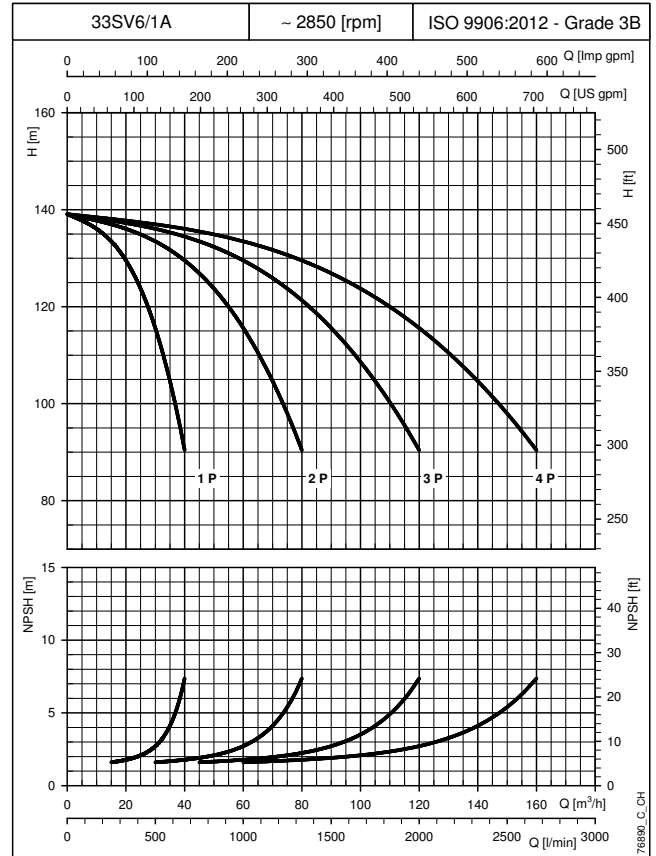
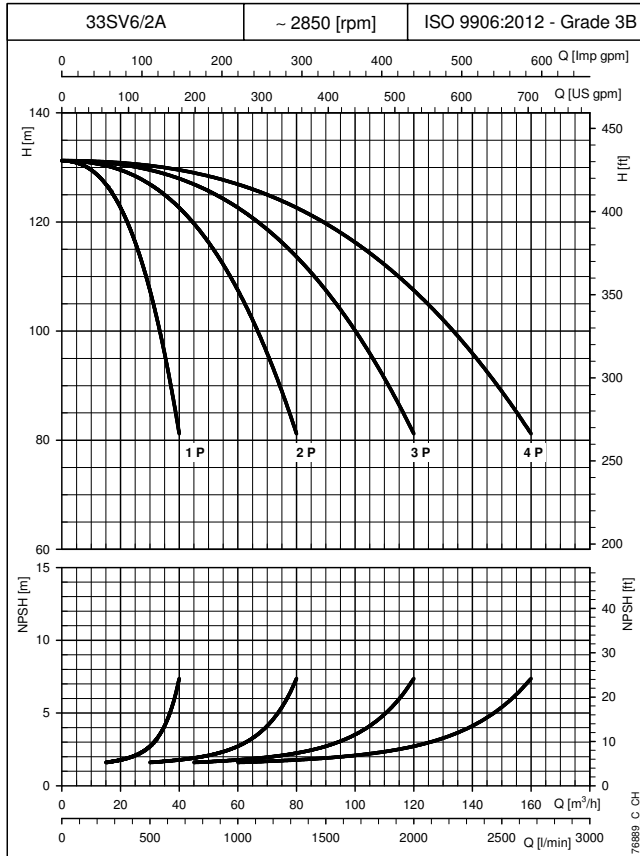

CURVE

The performance curves do not take into account flow resistance in the valves and piping.
 The curves show the performance with one and two pumps running.
 These performances are valid for liquids with density $\rho = 1.0 \text{ Kg/dm}^3$ and kinematic viscosity $\nu = 1 \text{ mm}^2/\text{s}$.
 The declared NPSH values are laboratory values: for practical use we recommend increasing these values by 0,5 m.

BOOSTER SETS, GVF.../SV SERIES OPERATING CHARACTERISTICS

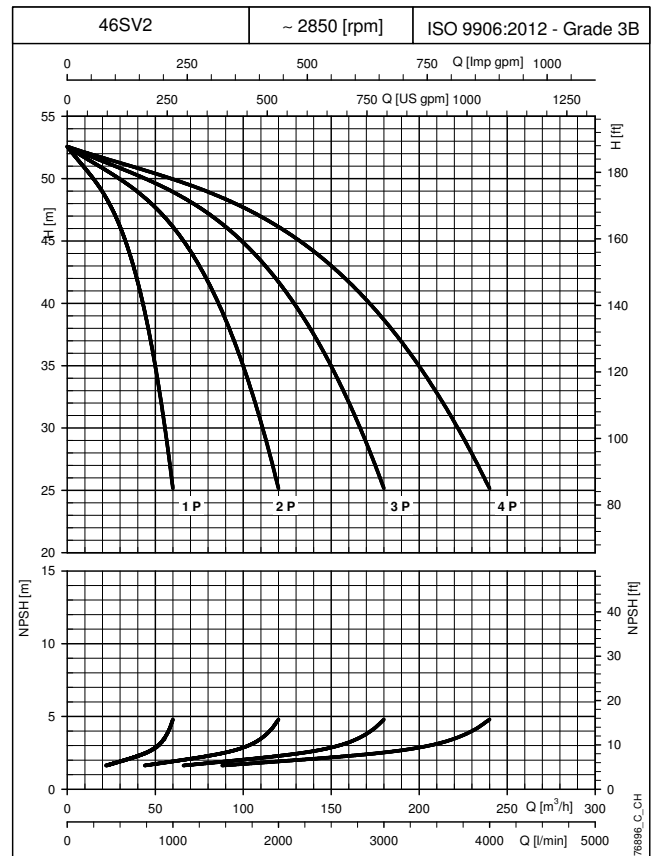
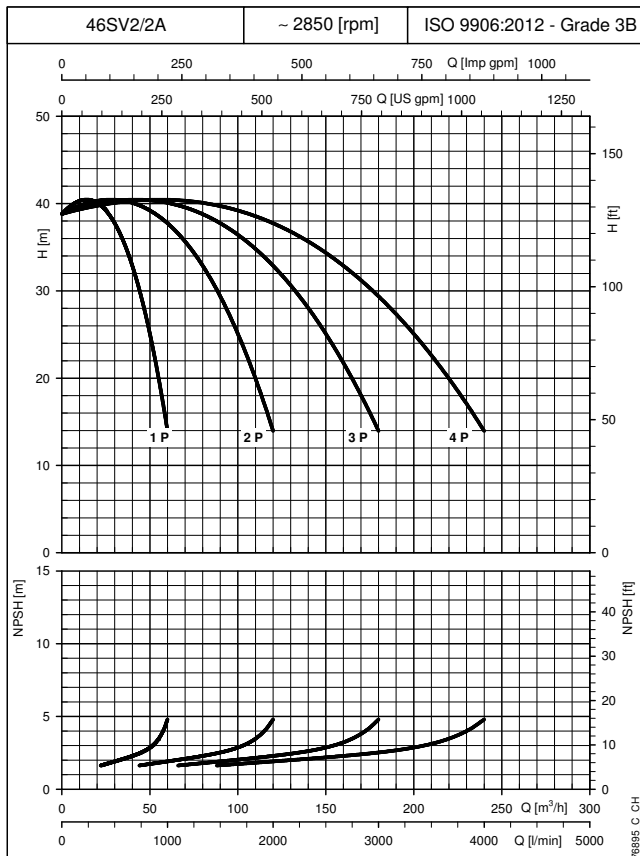
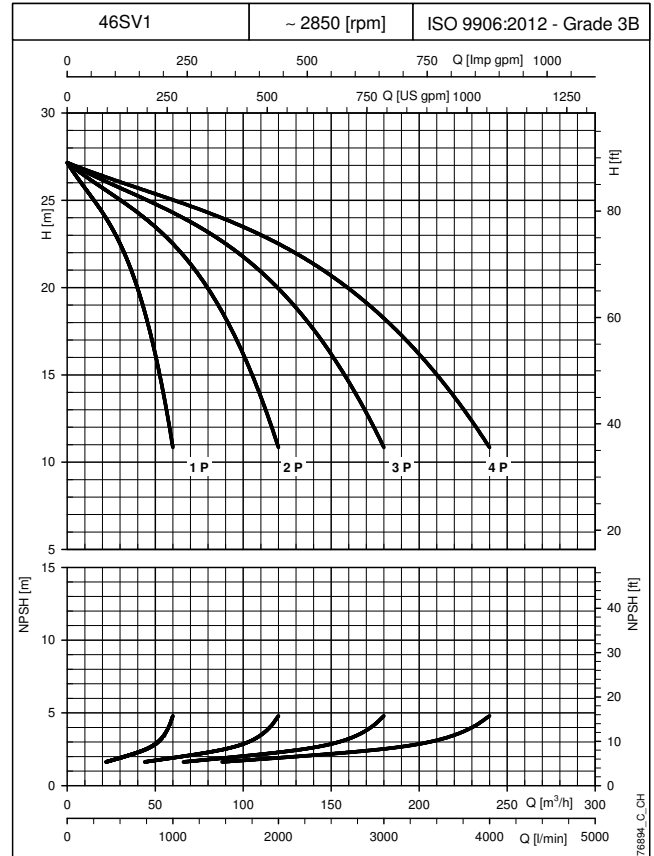
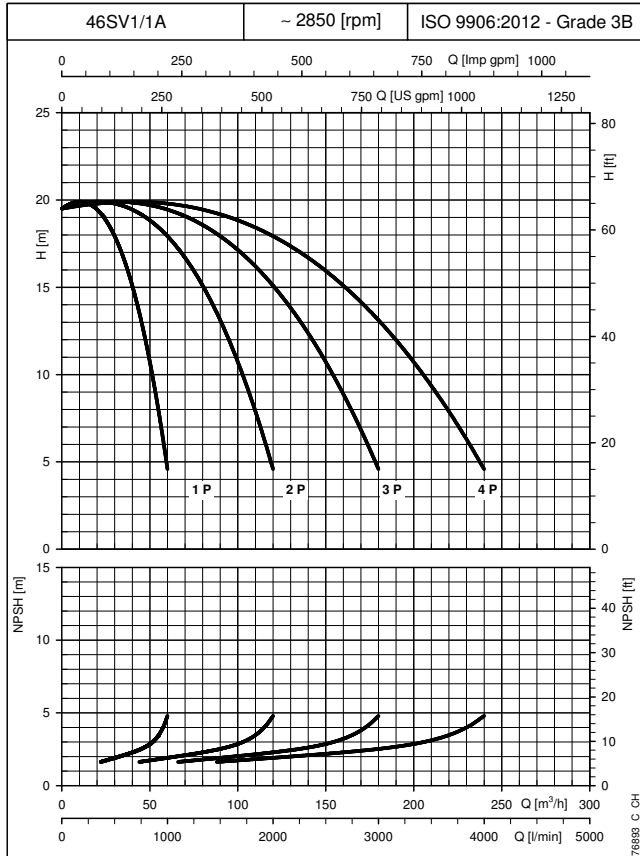

The performance curves do not take into account flow resistance in the valves and piping.
 The curves show the performance with one and two pumps running.
 These performances are valid for liquids with density $\rho = 1.0 \text{ Kg/dm}^3$ and kinematic viscosity $\nu = 1 \text{ mm}^2/\text{s}$.
 The declared NPSH values are laboratory values: for practical use we recommend increasing these values by 0,5 m.

CURVE

BOOSTER SETS, GVF.../SV SERIES OPERATING CHARACTERISTICS

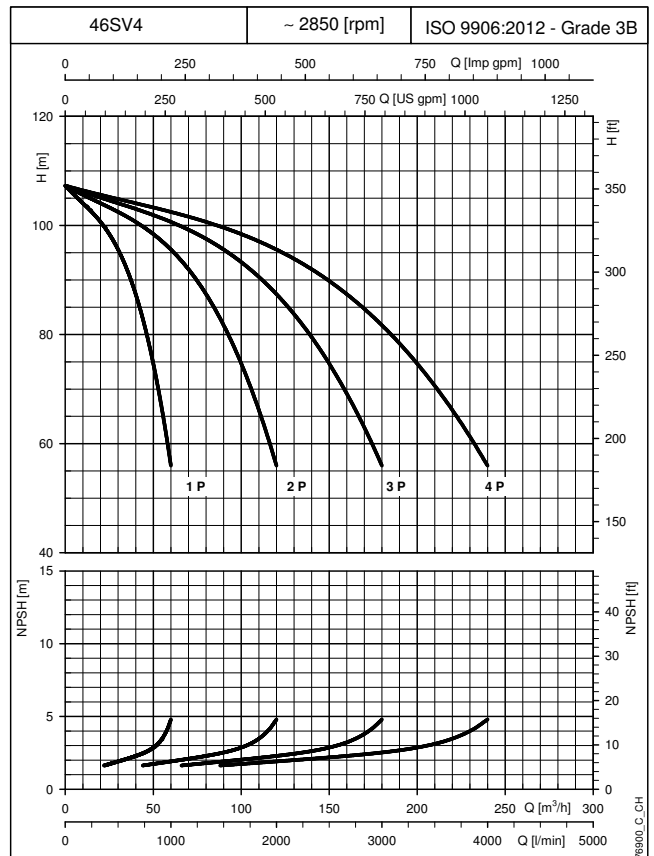
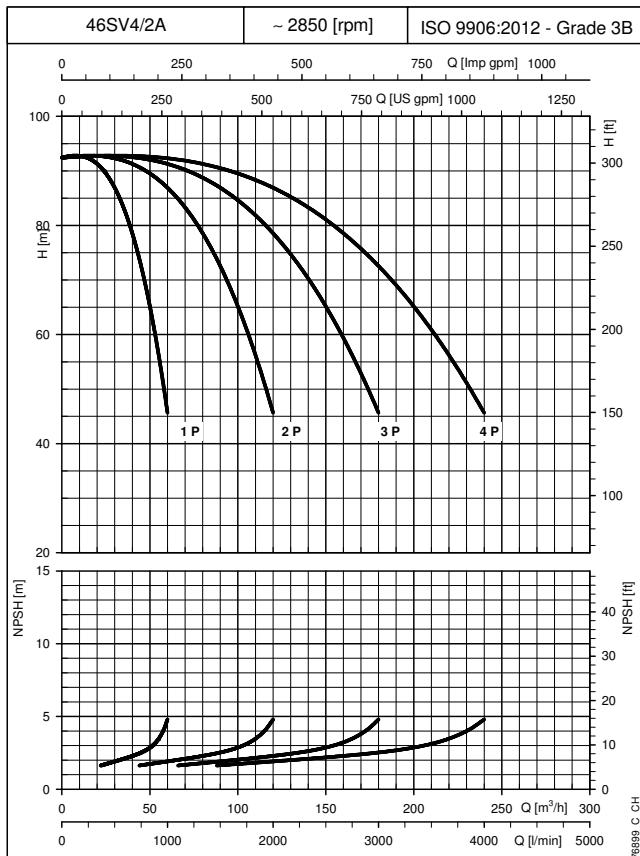
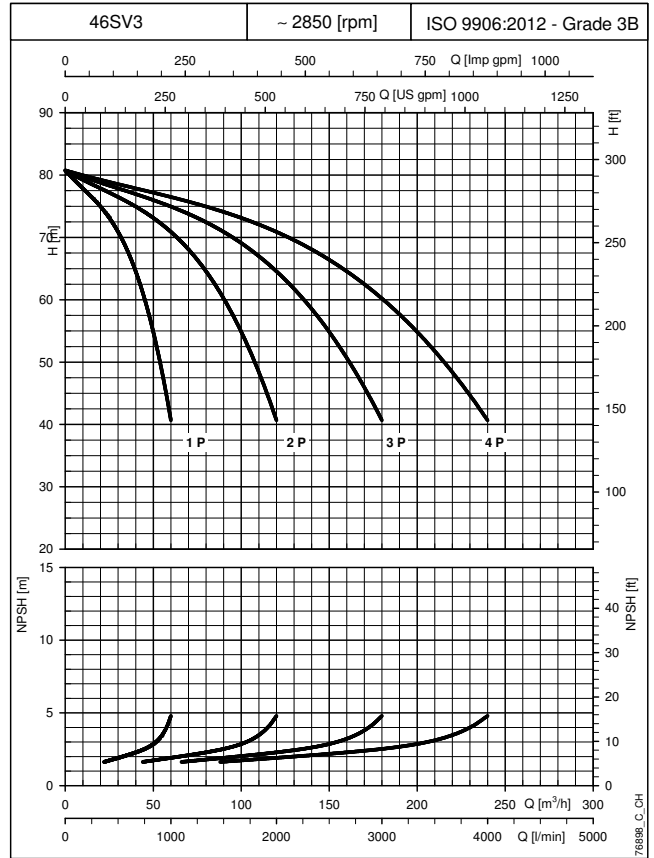
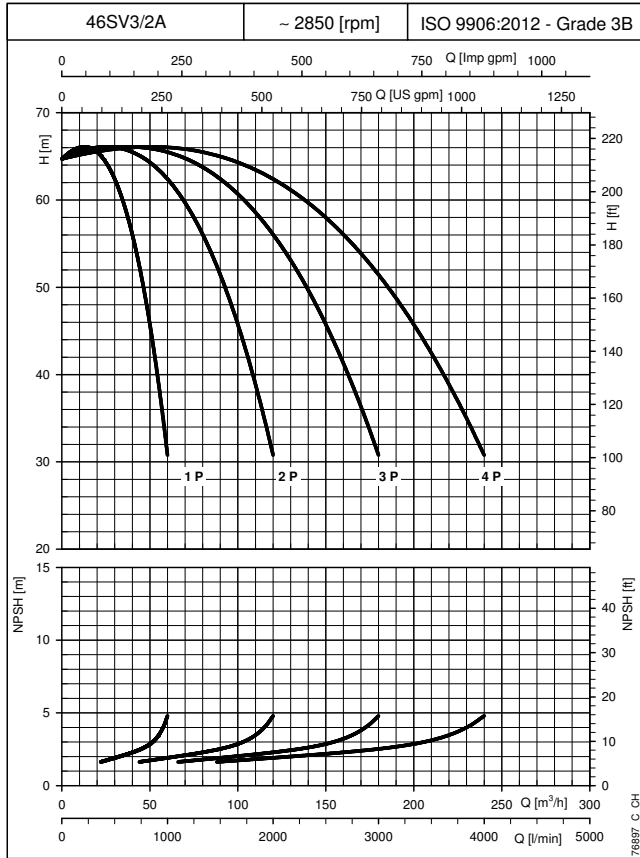

CURVE

The performance curves do not take into account flow resistance in the valves and piping.
 The curves show the performance with one and two pumps running.
 These performances are valid for liquids with density $\rho = 1.0 \text{ Kg/dm}^3$ and kinematic viscosity $\nu = 1 \text{ mm}^2/\text{s}$.
 The declared NPSH values are laboratory values: for practical use we recommend increasing these values by 0,5 m.

BOOSTER SETS, GVF.../SV SERIES OPERATING CHARACTERISTICS

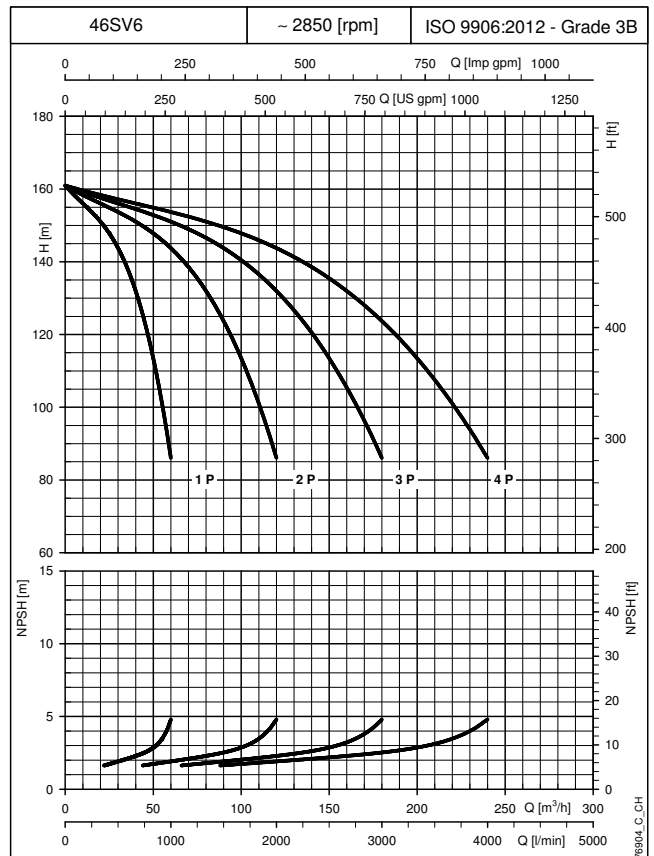
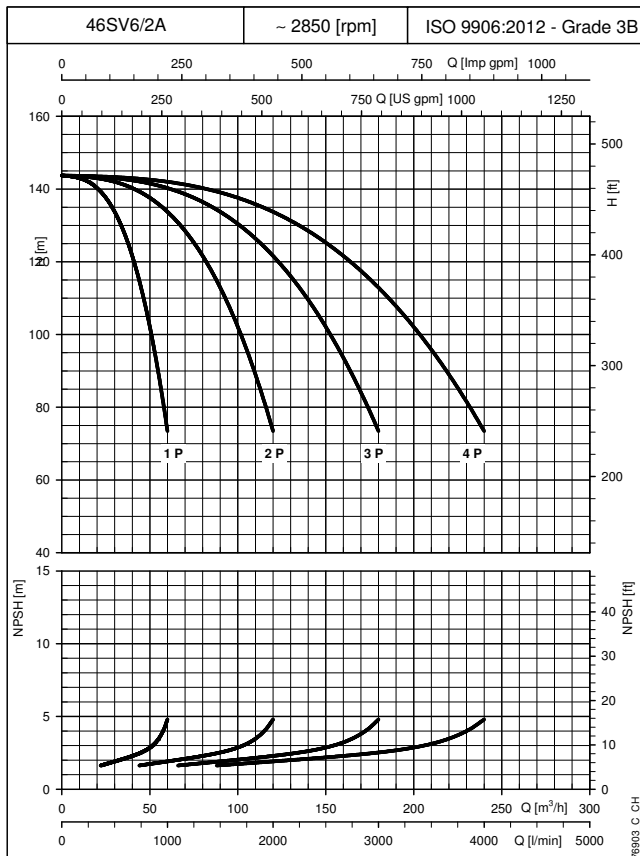
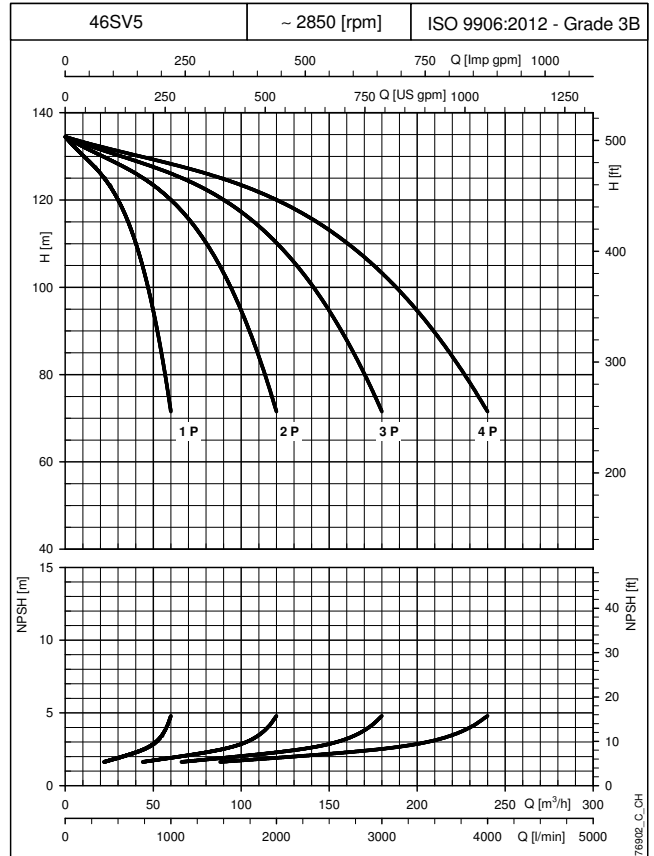
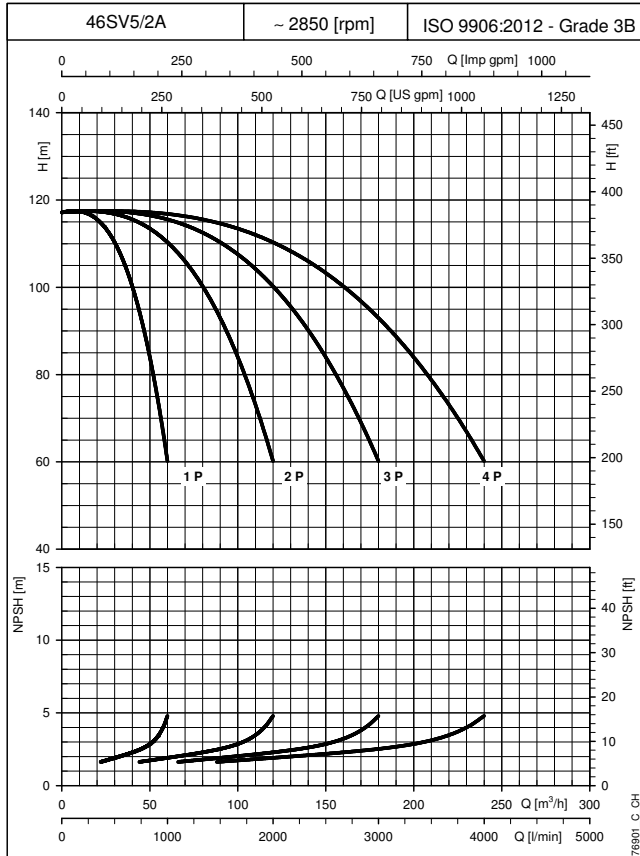

The performance curves do not take into account flow resistance in the valves and piping.
 The curves show the performance with one and two pumps running.
 These performances are valid for liquids with density $\rho = 1.0 \text{ Kg/dm}^3$ and kinematic viscosity $\nu = 1 \text{ mm}^2/\text{s}$.
 The declared NPSH values are laboratory values: for practical use we recommend increasing these values by 0,5 m.

CURVE

BOOSTER SETS, GVF.../SV SERIES OPERATING CHARACTERISTICS

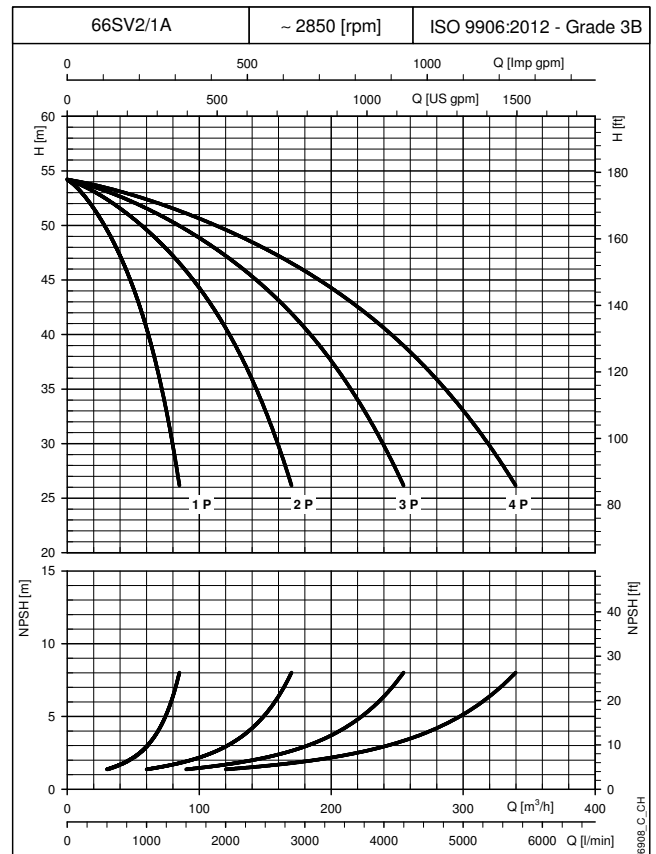
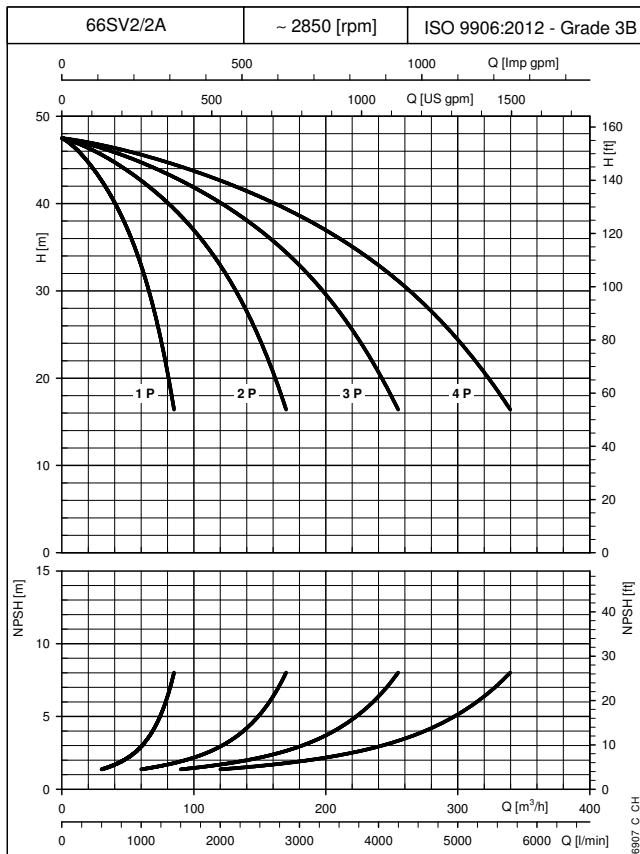
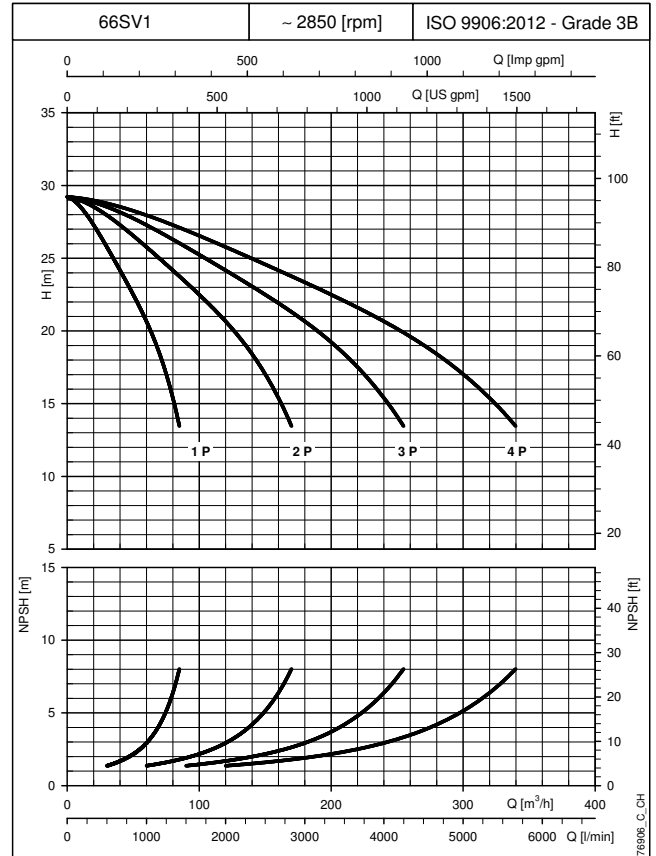
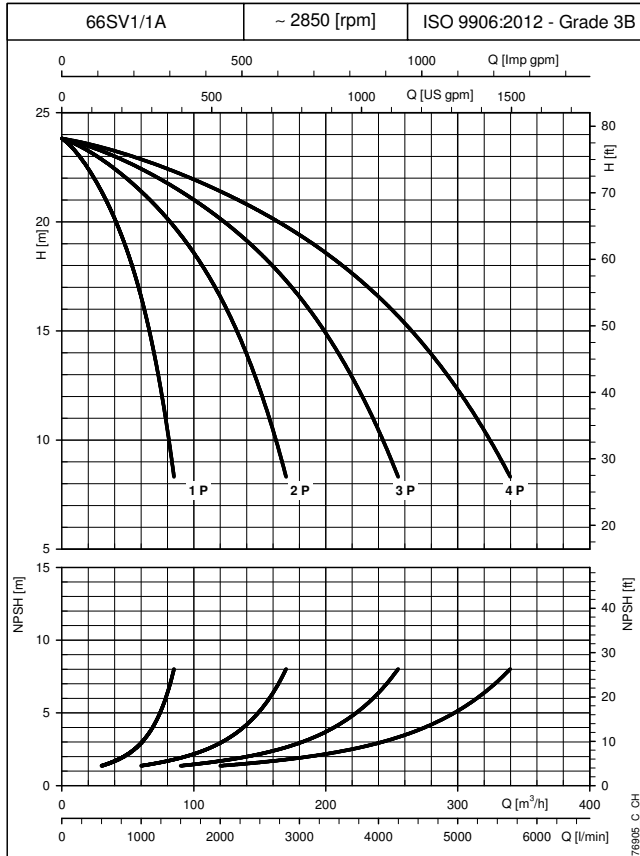

CURVE

The performance curves do not take into account flow resistance in the valves and piping.
 The curves show the performance with one and two pumps running.
 These performances are valid for liquids with density $\rho = 1.0 \text{ Kg/dm}^3$ and kinematic viscosity $\nu = 1 \text{ mm}^2/\text{s}$.
 The declared NPSH values are laboratory values: for practical use we recommend increasing these values by 0,5 m.

BOOSTER SETS, GVF.../SV SERIES OPERATING CHARACTERISTICS

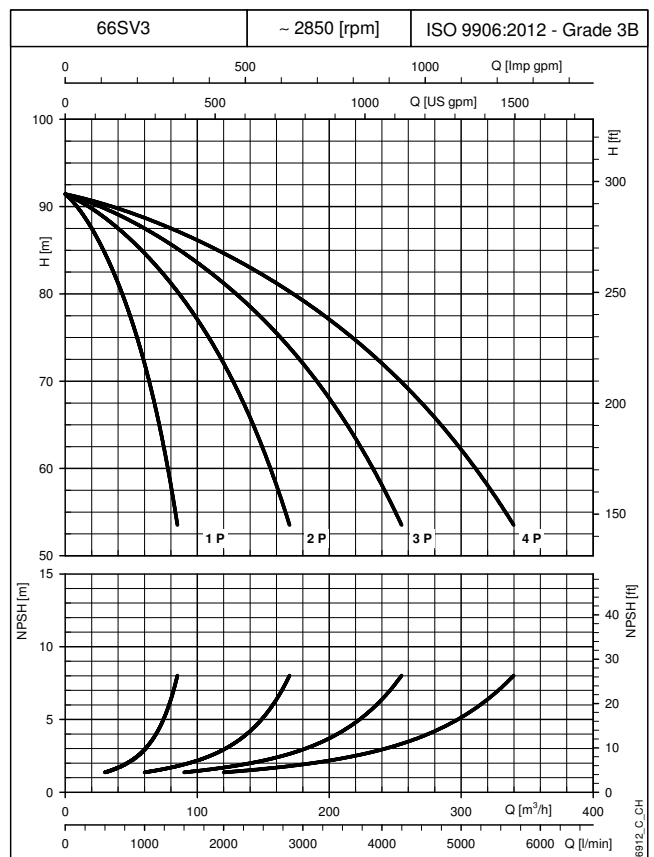
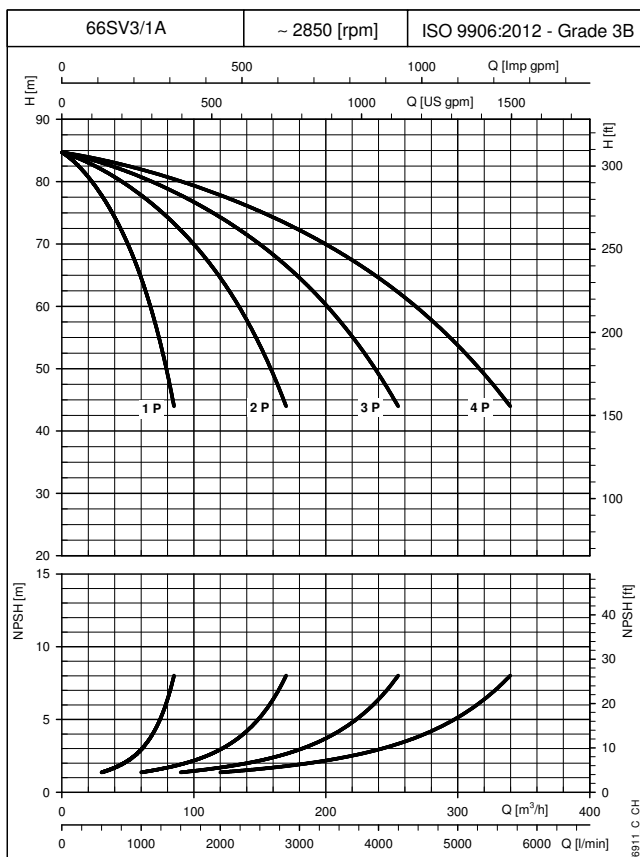
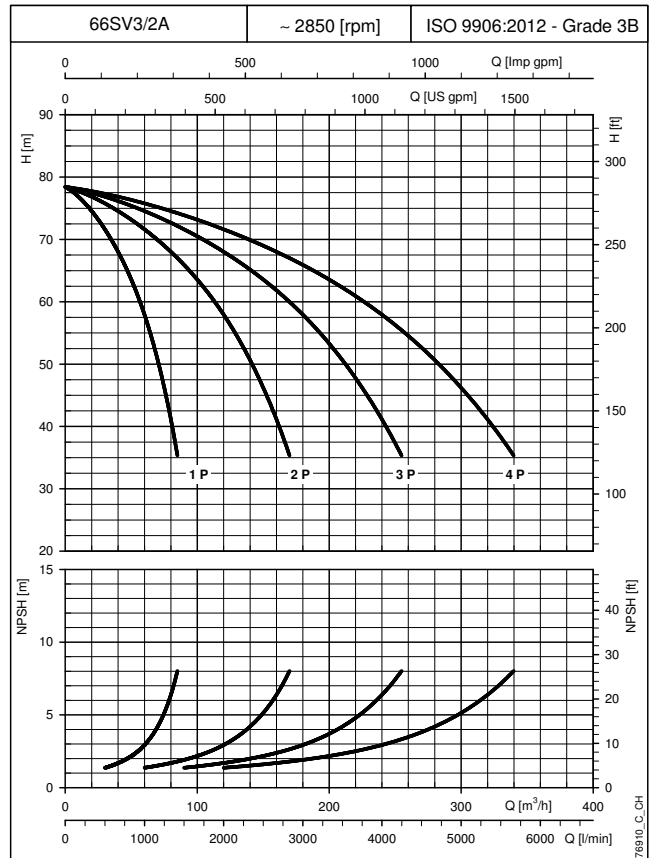
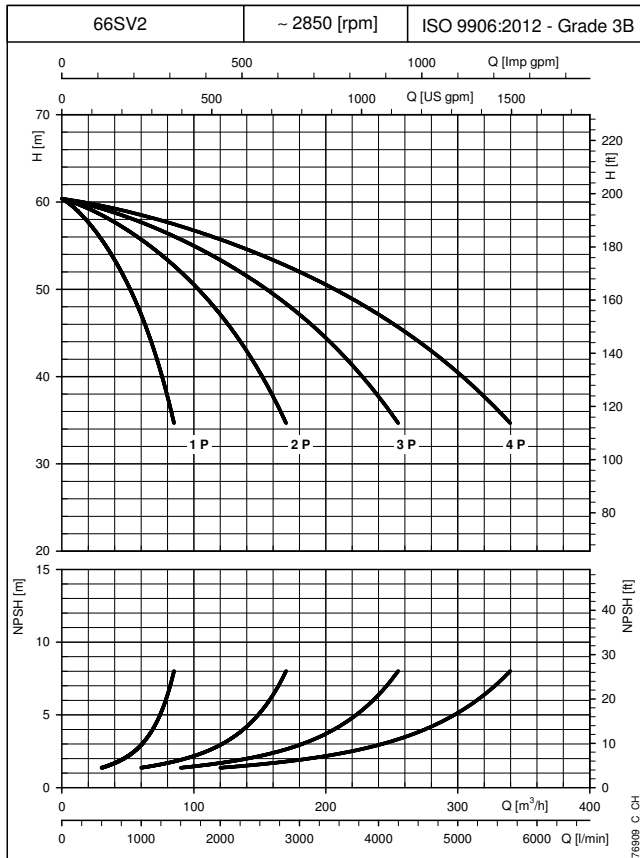

The performance curves do not take into account flow resistance in the valves and piping.
 The curves show the performance with one and two pumps running.
 These performances are valid for liquids with density $\rho = 1.0 \text{ Kg/dm}^3$ and kinematic viscosity $\nu = 1 \text{ mm}^2/\text{s}$.
 The declared NPSH values are laboratory values: for practical use we recommend increasing these values by 0,5 m.

CURVE

BOOSTER SETS, GVF.../SV SERIES OPERATING CHARACTERISTICS

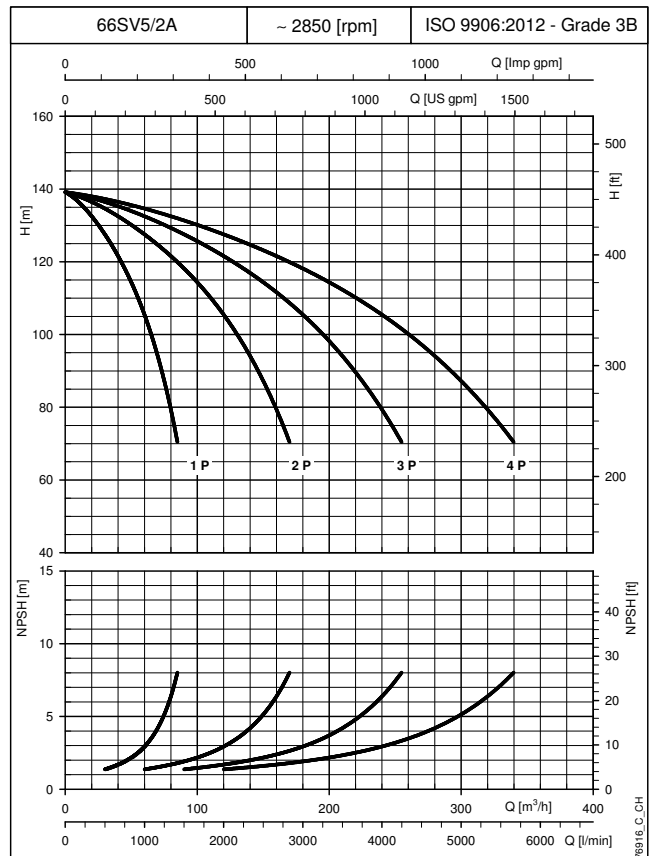
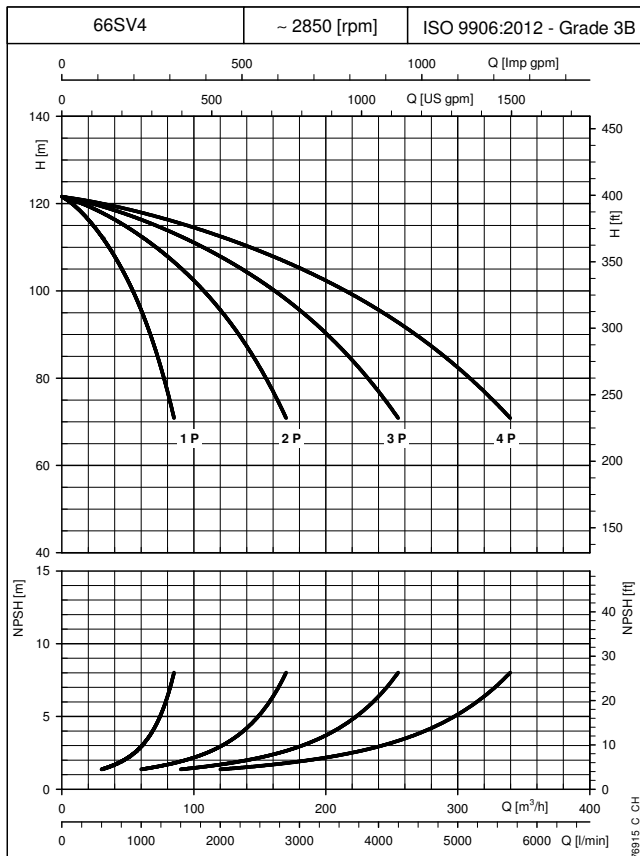
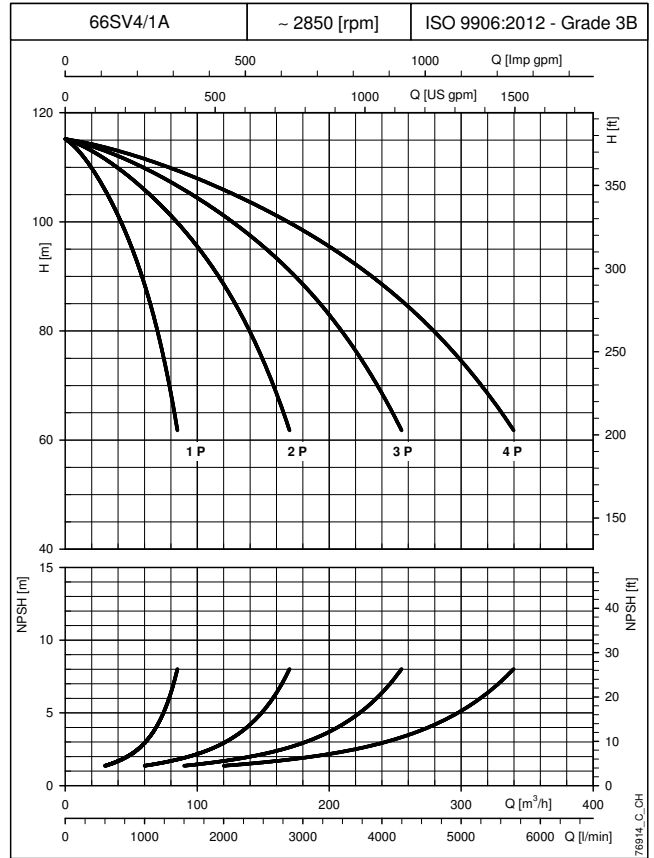
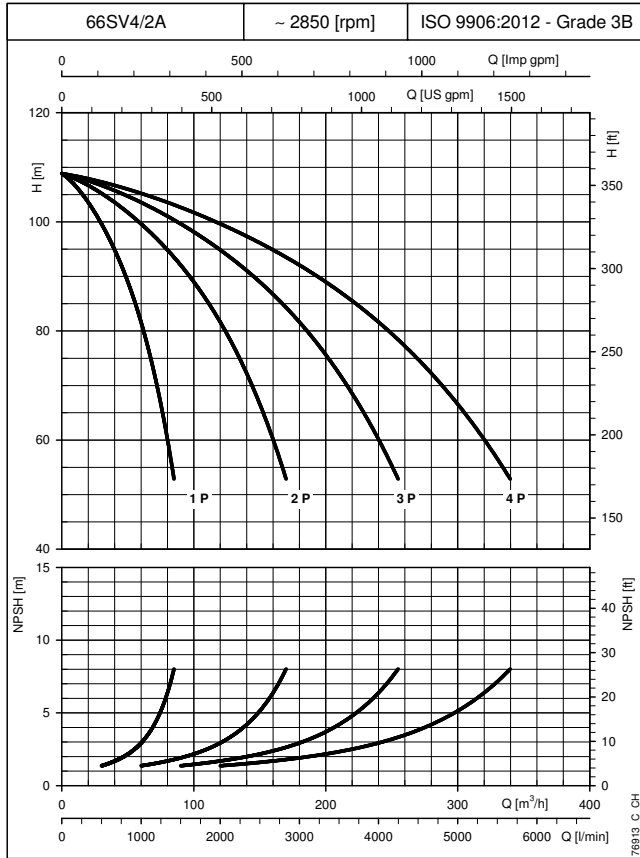

CURVE

The performance curves do not take into account flow resistance in the valves and piping.
 The curves show the performance with one and two pumps running.
 These performances are valid for liquids with density $\rho = 1.0 \text{ Kg/dm}^3$ and kinematic viscosity $\nu = 1 \text{ mm}^2/\text{s}$.
 The declared NPSH values are laboratory values: for practical use we recommend increasing these values by 0,5 m.

BOOSTER SETS, GVF.../SV SERIES OPERATING CHARACTERISTICS

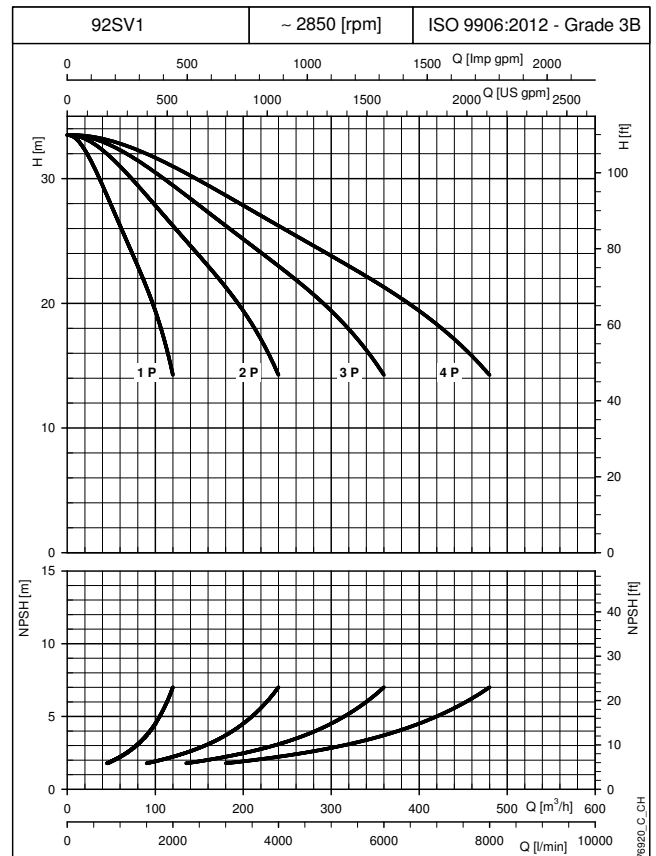
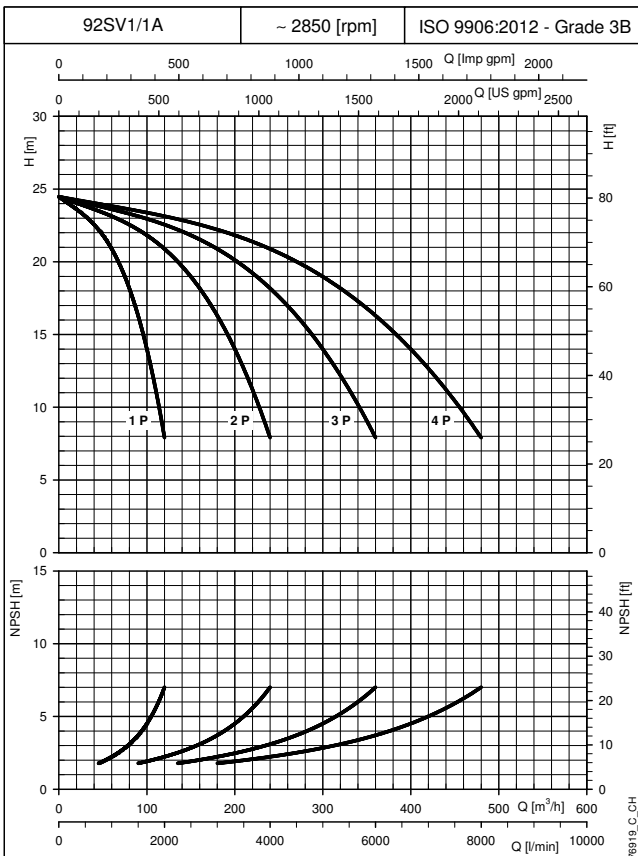
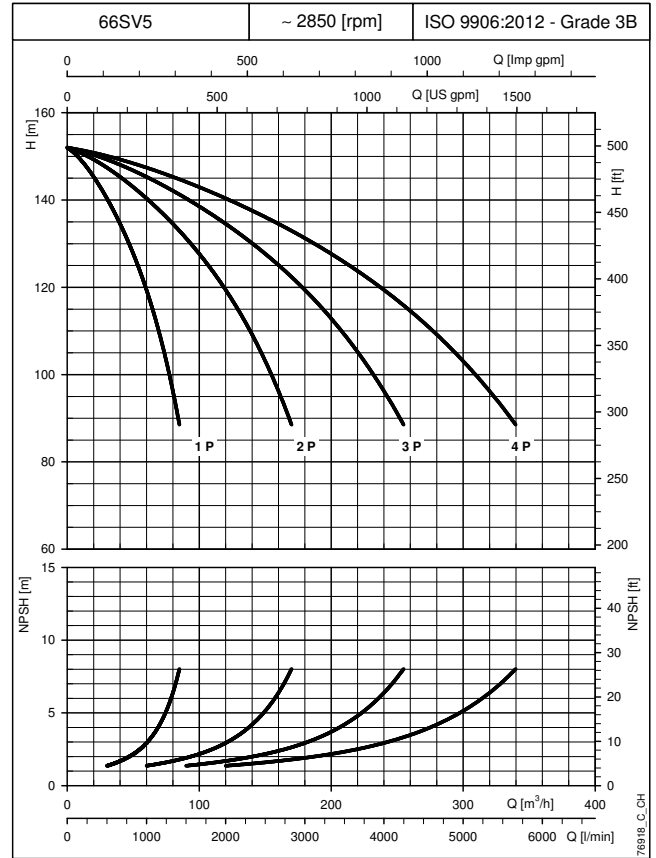
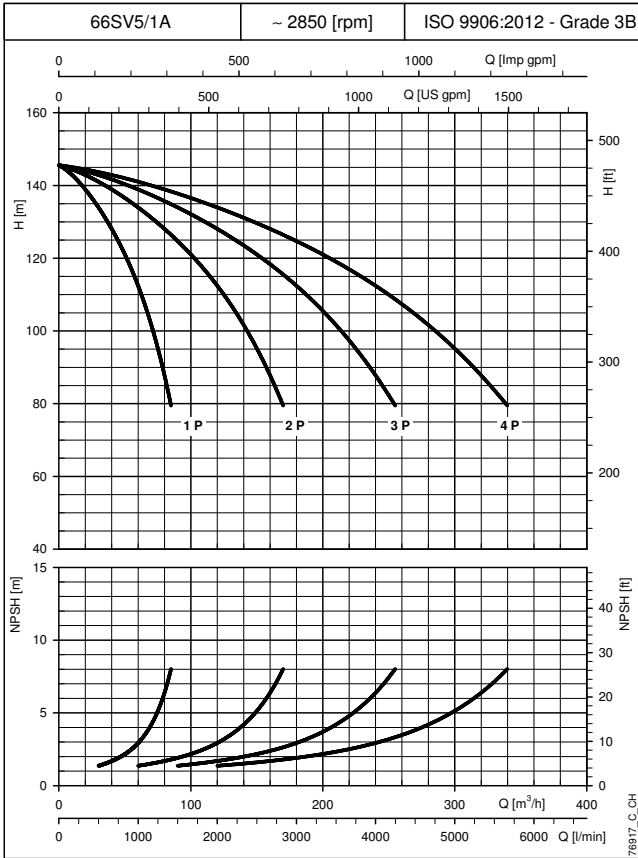

The performance curves do not take into account flow resistance in the valves and piping.
 The curves show the performance with one and two pumps running.
 These performances are valid for liquids with density $\rho = 1.0 \text{ Kg/dm}^3$ and kinematic viscosity $\nu = 1 \text{ mm}^2/\text{s}$.
 The declared NPSH values are laboratory values: for practical use we recommend increasing these values by 0,5 m.

CURVE

BOOSTER SETS, GVF.../SV SERIES OPERATING CHARACTERISTICS

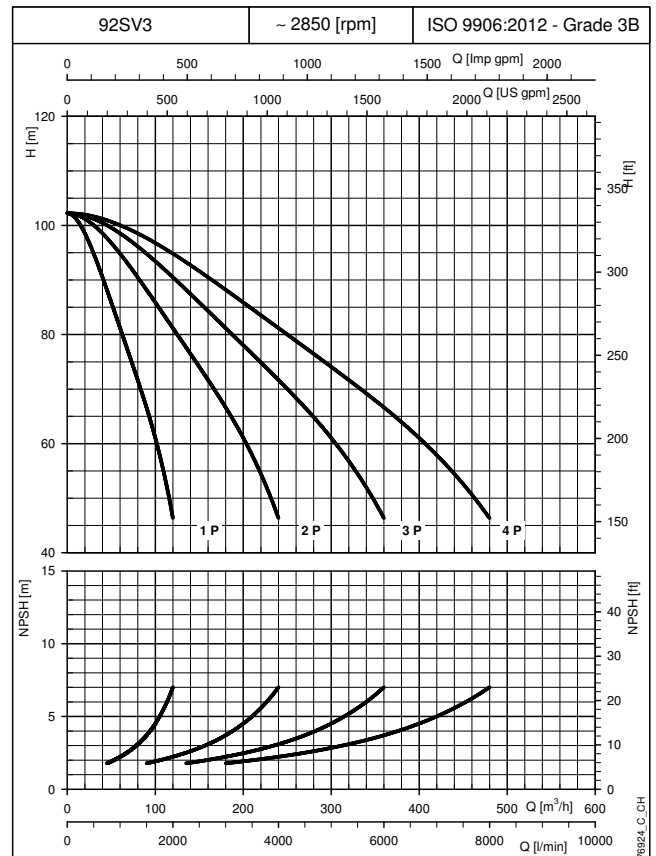
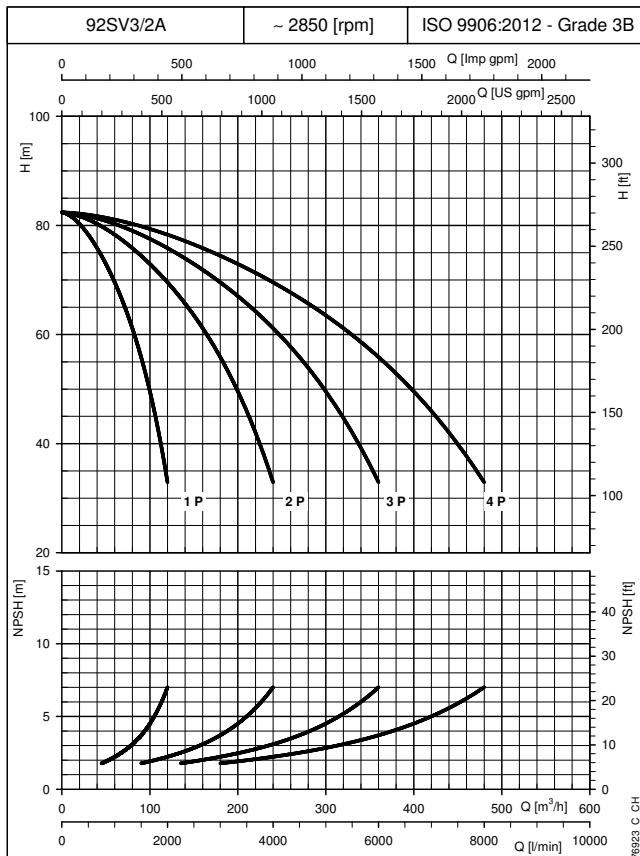
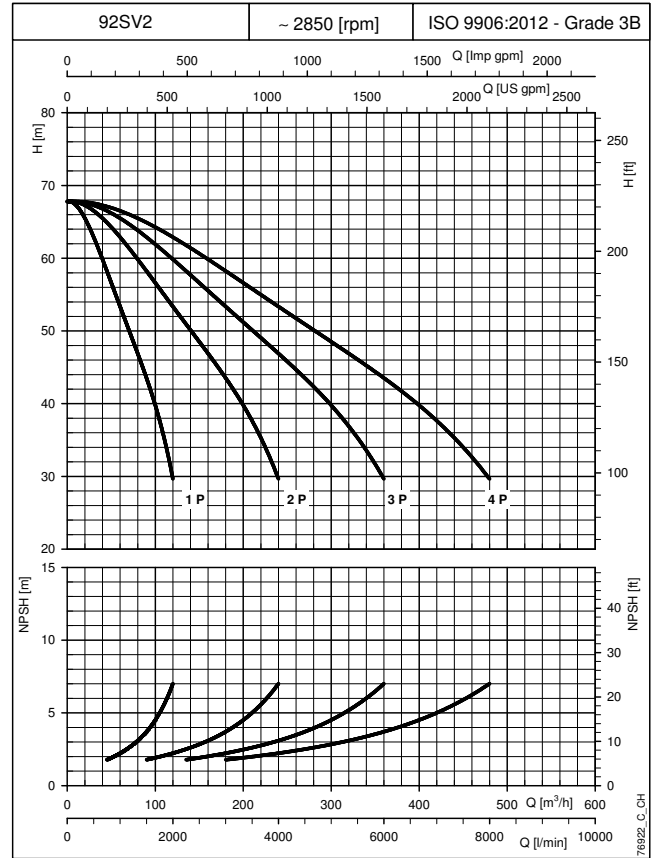
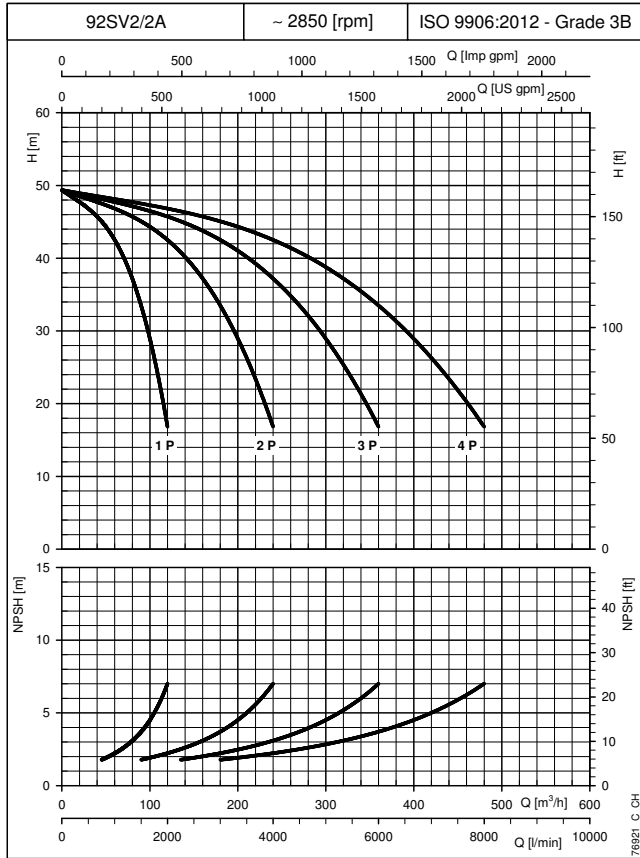

CURVE

The performance curves do not take into account flow resistance in the valves and piping.
 The curves show the performance with one and two pumps running.
 These performances are valid for liquids with density $\rho = 1.0 \text{ Kg/dm}^3$ and kinematic viscosity $\nu = 1 \text{ mm}^2/\text{s}$.
 The declared NPSH values are laboratory values: for practical use we recommend increasing these values by 0,5 m.

BOOSTER SETS, GVF.../SV SERIES OPERATING CHARACTERISTICS

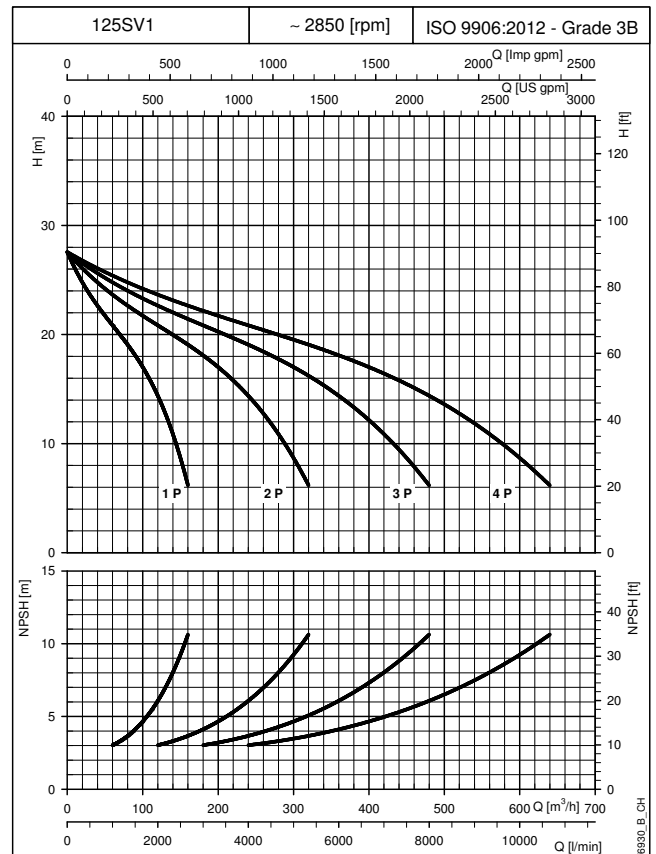
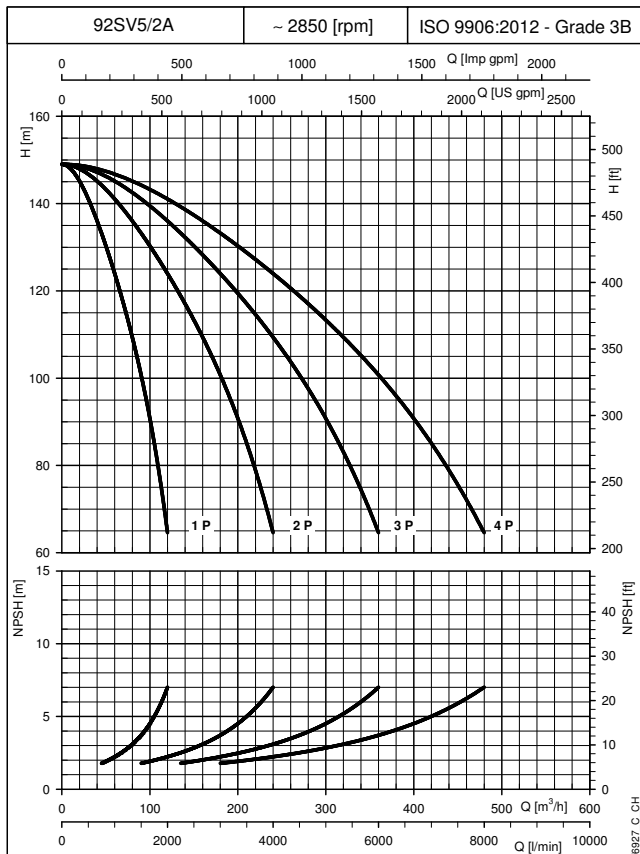
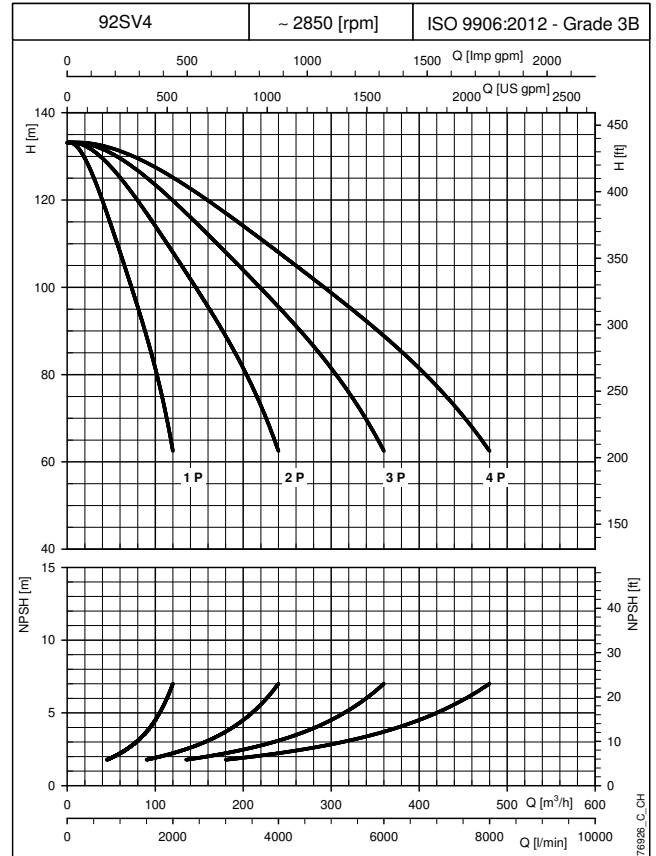
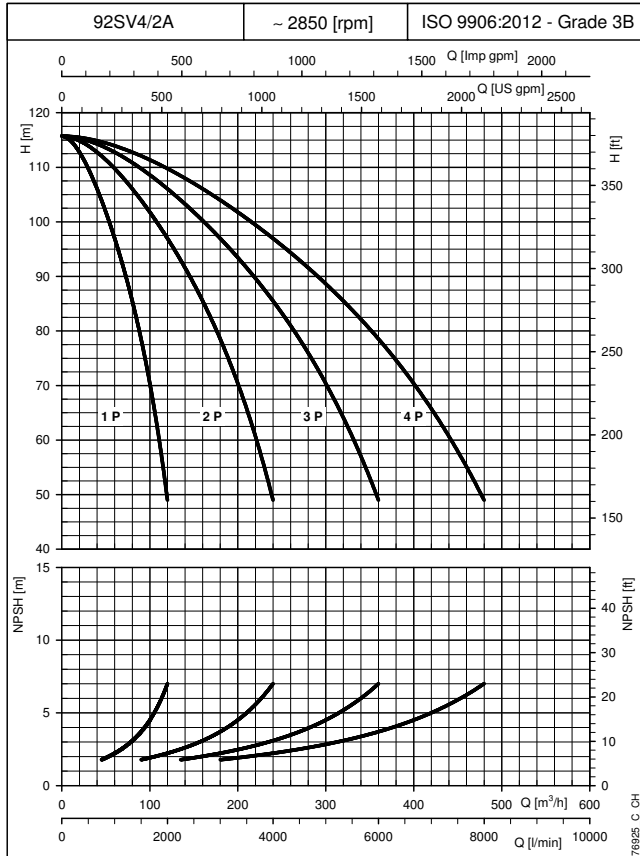

The performance curves do not take into account flow resistance in the valves and piping.
 The curves show the performance with one and two pumps running.
 These performances are valid for liquids with density $\rho = 1.0 \text{ Kg/dm}^3$ and kinematic viscosity $\nu = 1 \text{ mm}^2/\text{s}$.
 The declared NPSH values are laboratory values: for practical use we recommend increasing these values by 0,5 m.

CURVE

BOOSTER SETS, GVF.../SV SERIES OPERATING CHARACTERISTICS

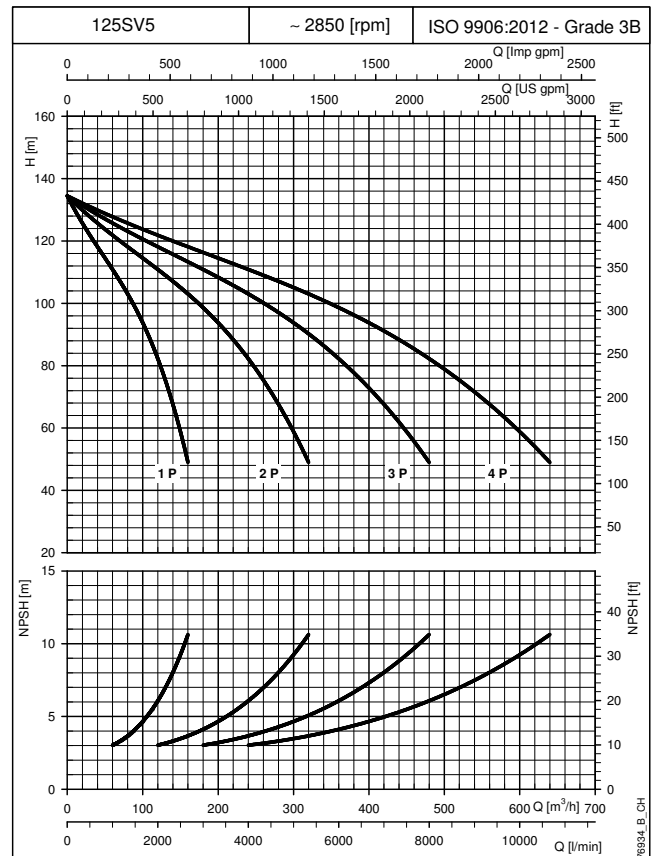
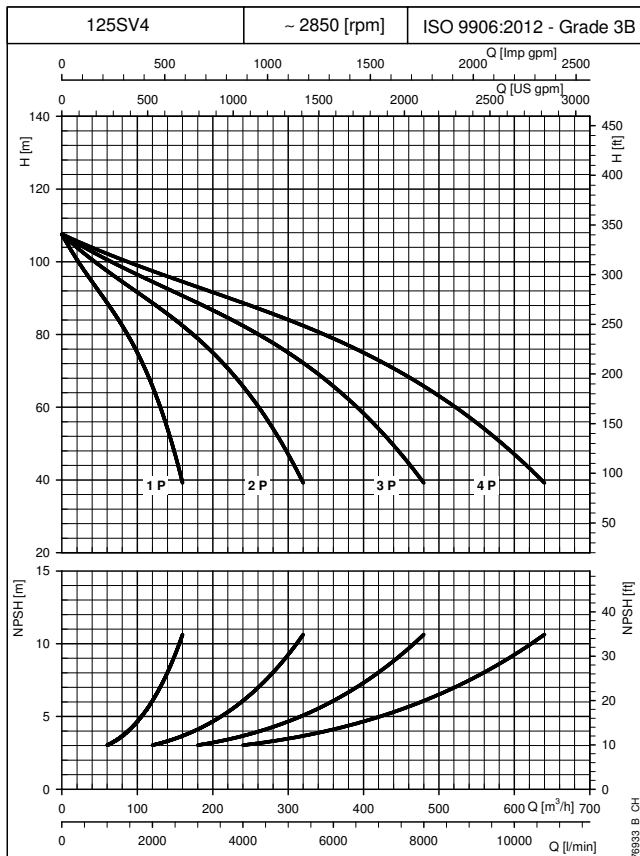
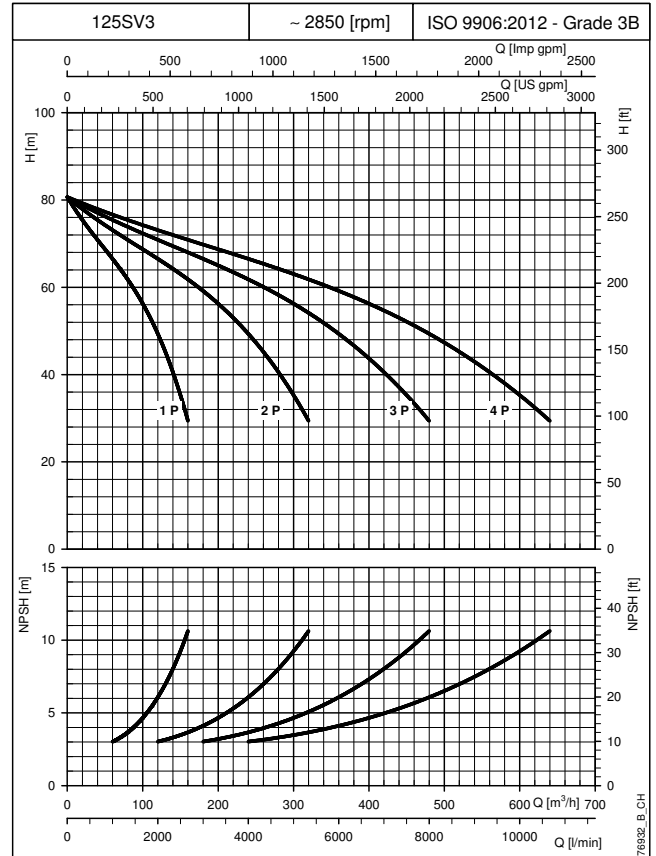
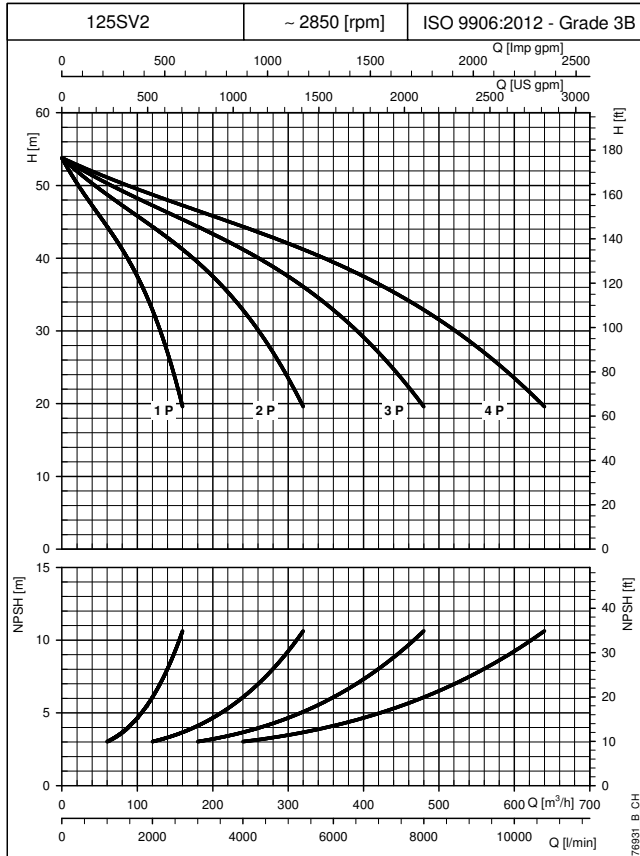

CURVE

The performance curves do not take into account flow resistance in the valves and piping.
 The curves show the performance with one and two pumps running.
 These performances are valid for liquids with density $\rho = 1.0 \text{ Kg/dm}^3$ and kinematic viscosity $\nu = 1 \text{ mm}^2/\text{s}$.
 The declared NPSH values are laboratory values: for practical use we recommend increasing these values by 0,5 m.

**BOOSTER SETS, GVF.../SV SERIES
H_c PRESSURE DROP CURVE**

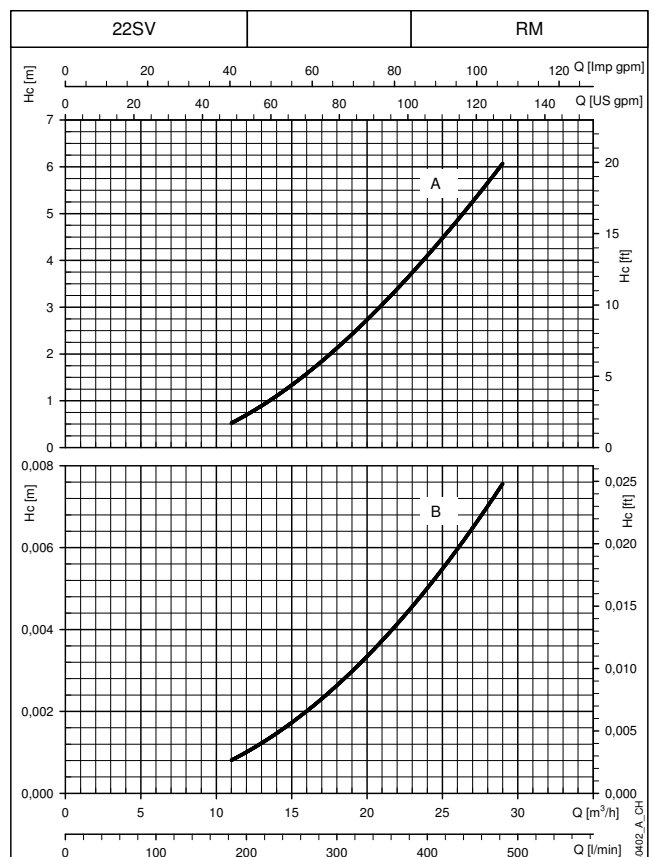
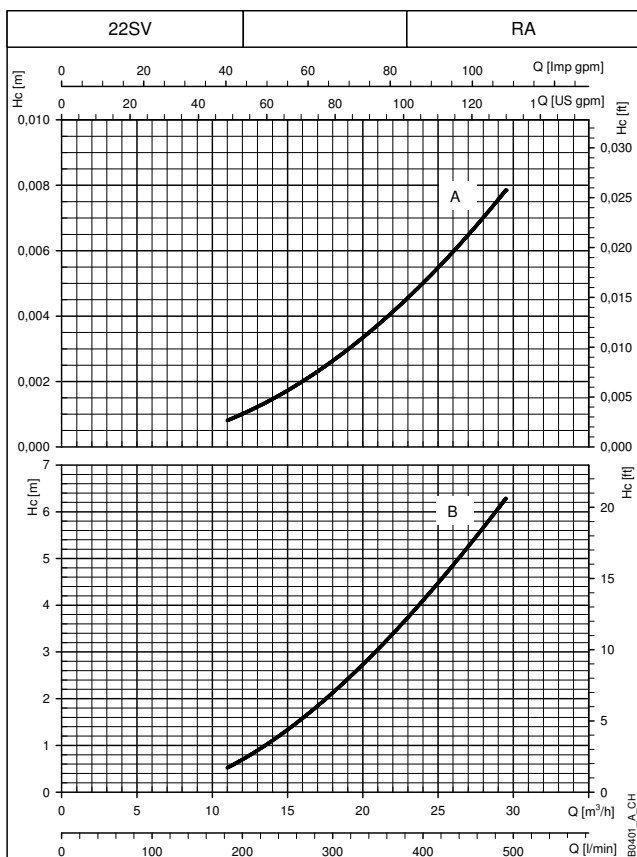
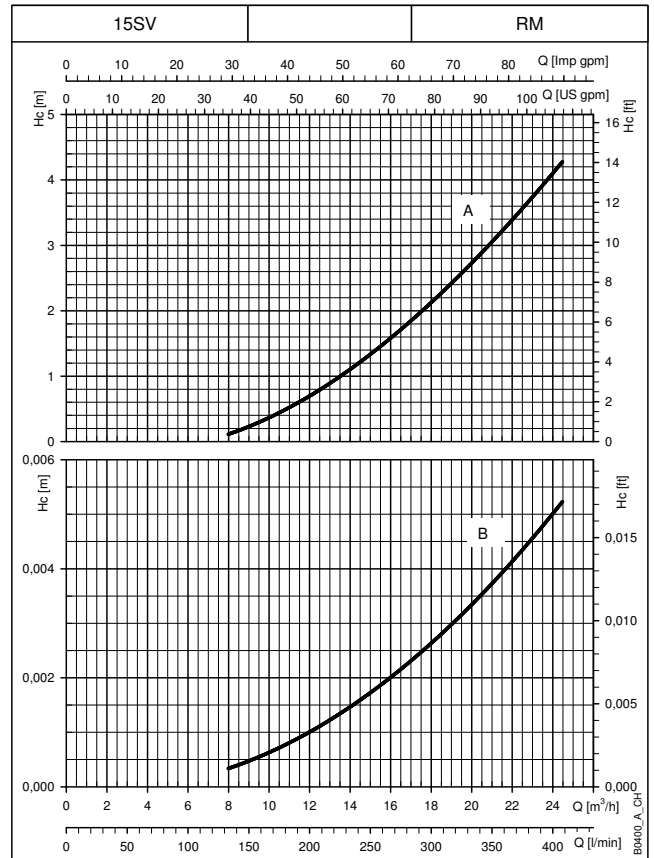
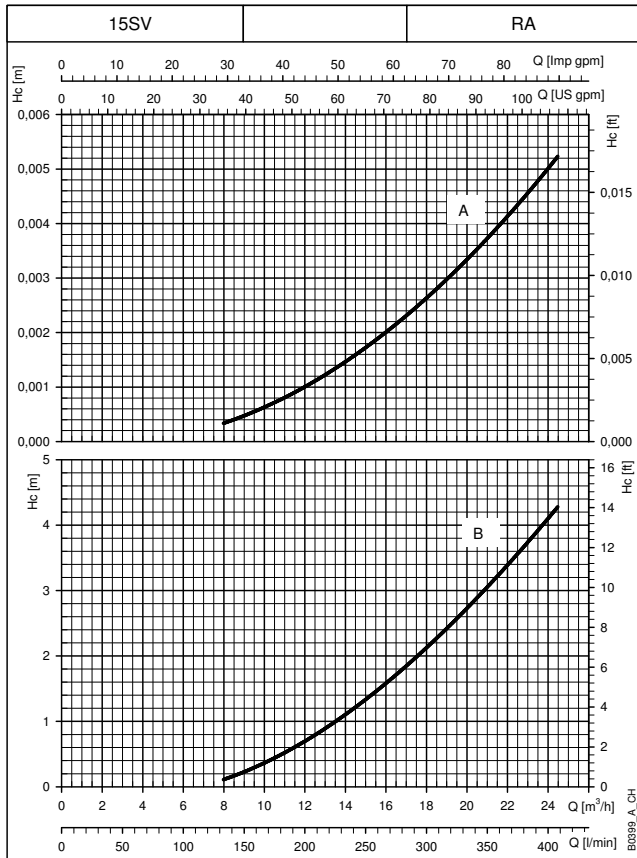

The declared curves are valid for liquids with density $\rho = 1 \text{ Kg/dm}^3$ and kinematic viscosity $\nu = 1 \text{ mm}^2/\text{sec}$.
 Hc (A): Pressure drop curve on delivery side of the pump. Hc (B): Pressure drop curve on suction side of the pump.
 RA: check valve on suction side. RM: check valve on delivery side.
 The pressure drops do not consider the distributed pressure drops on the manifold.

CURVE

BOOSTER SETS, GVF.../SV SERIES H_c PRESSURE DROP CURVE

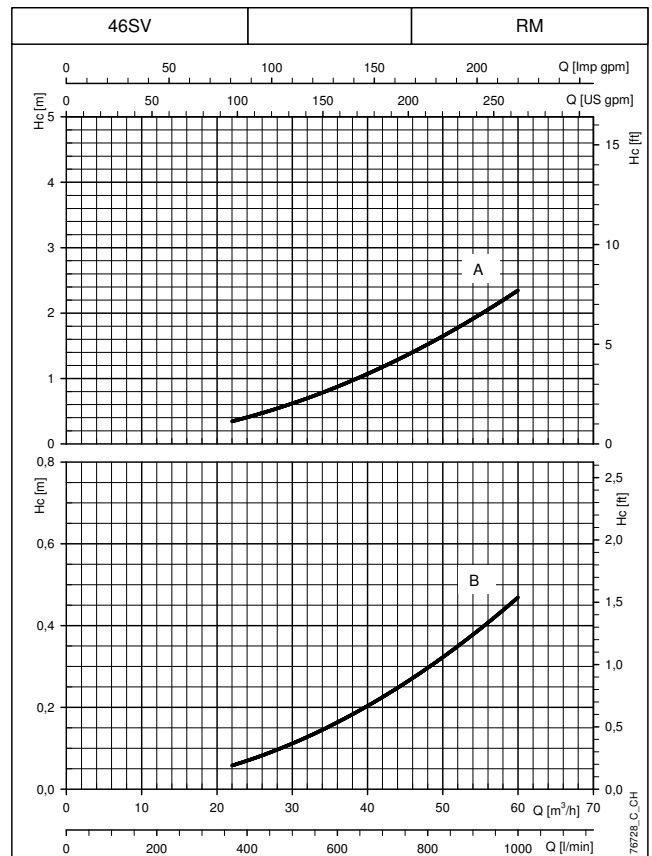
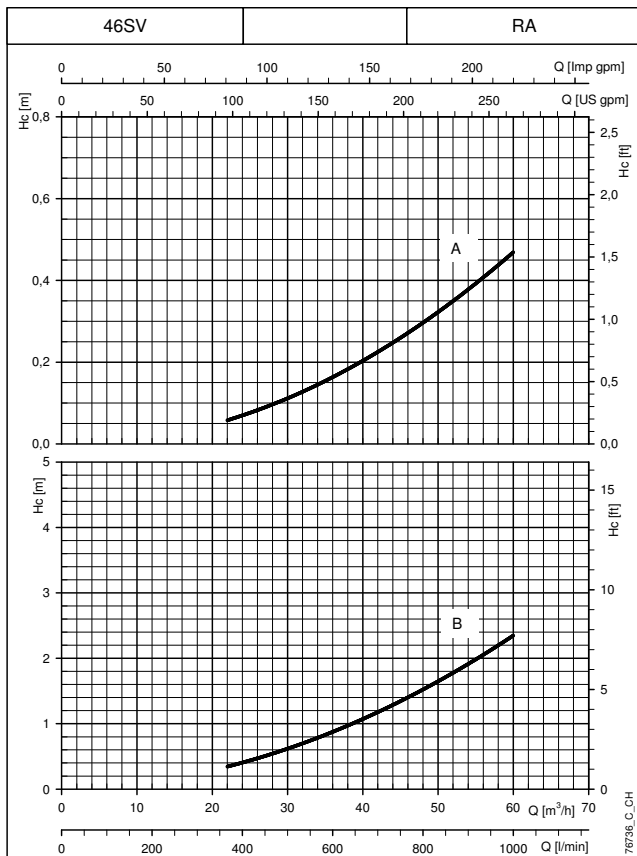
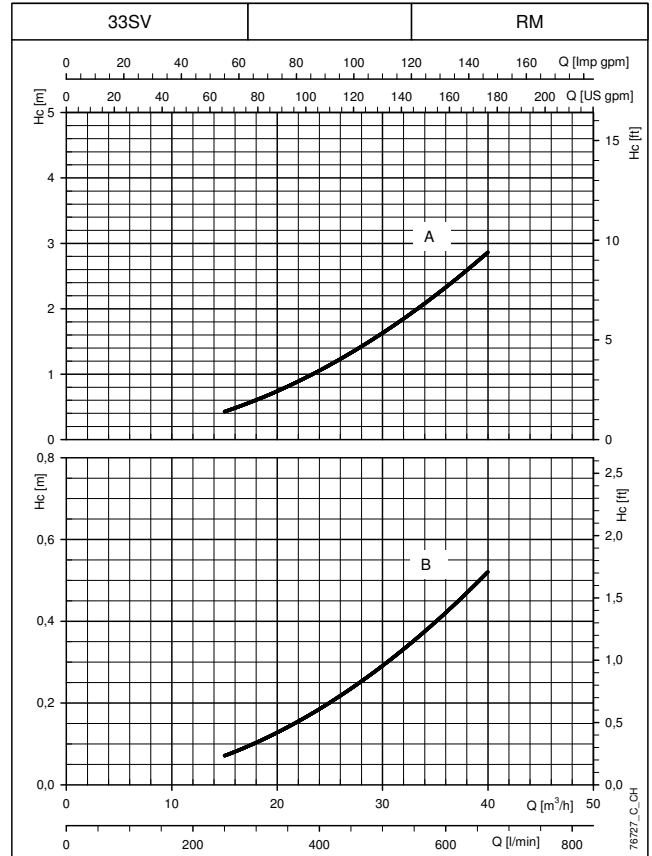
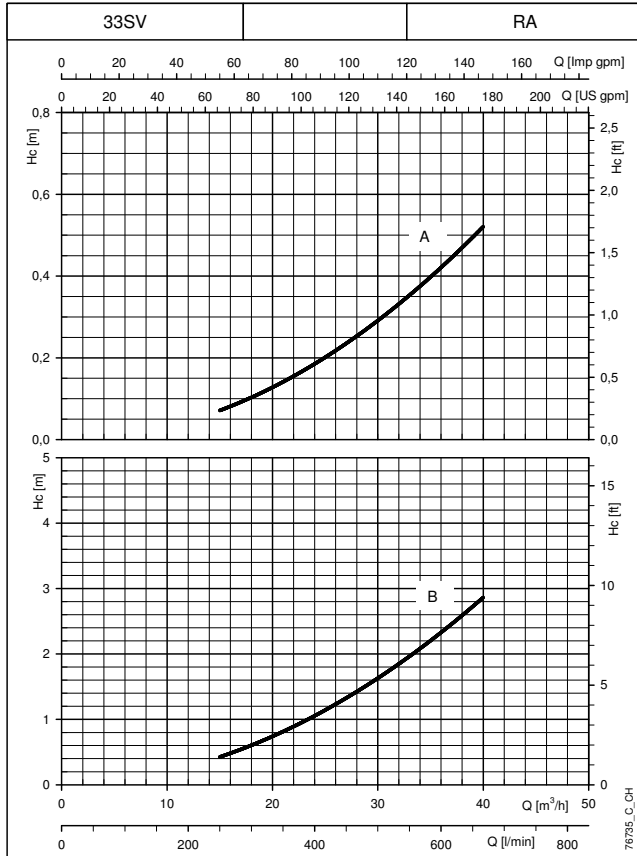

CURVE

The declared curves are valid for liquids with density $\rho = 1 \text{ Kg/dm}^3$ and kinematic viscosity $\nu = 1 \text{ mm}^2/\text{sec}$.
H_c (A): Pressure drop curve on delivery side of the pump. H_c (B): Pressure drop curve on suction side of the pump.
RA: check valve on suction side. RM: check valve on delivery side.
The pressure drops do not consider the distributed pressure drops on the manifold.

BOOSTER SETS, GVF.../SV SERIES H_c PRESSURE DROP CURVE

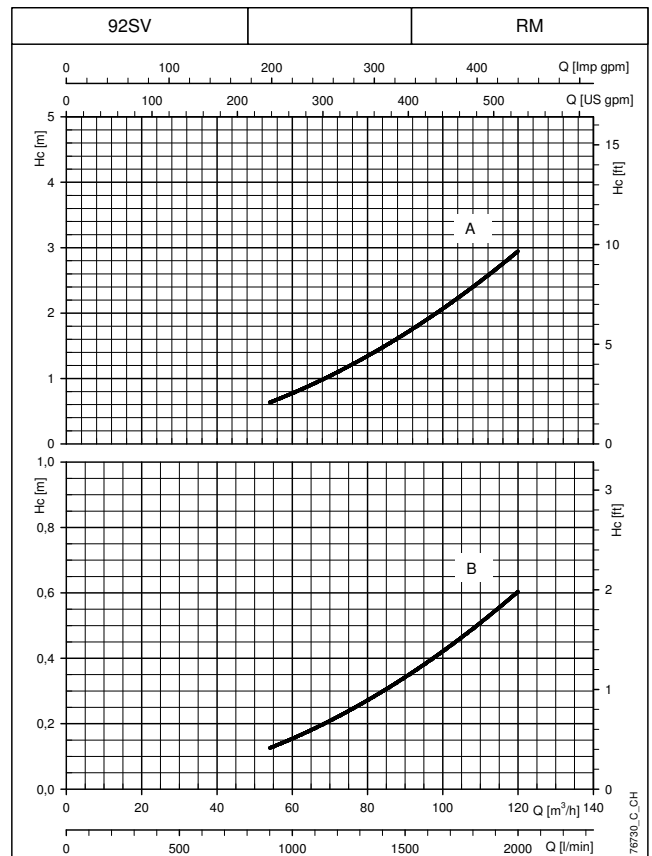
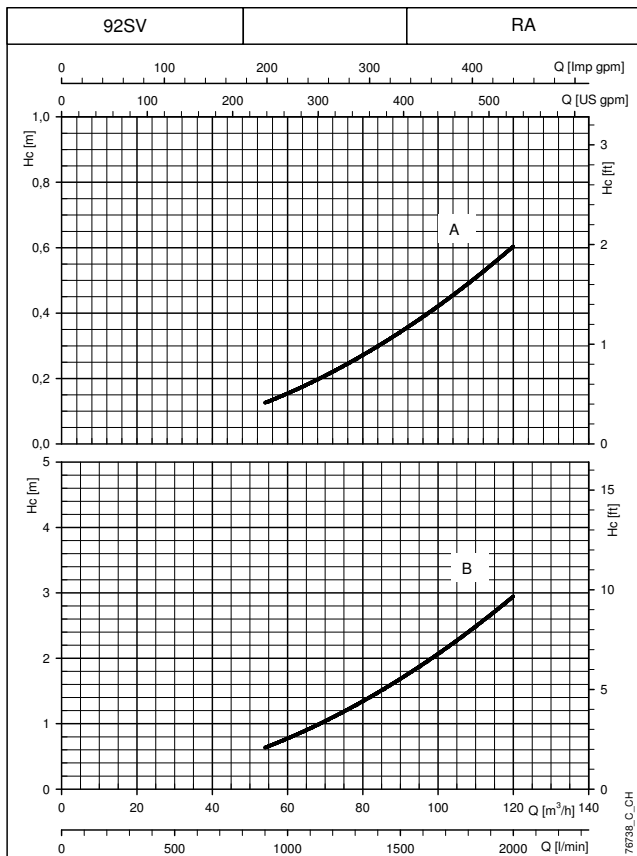
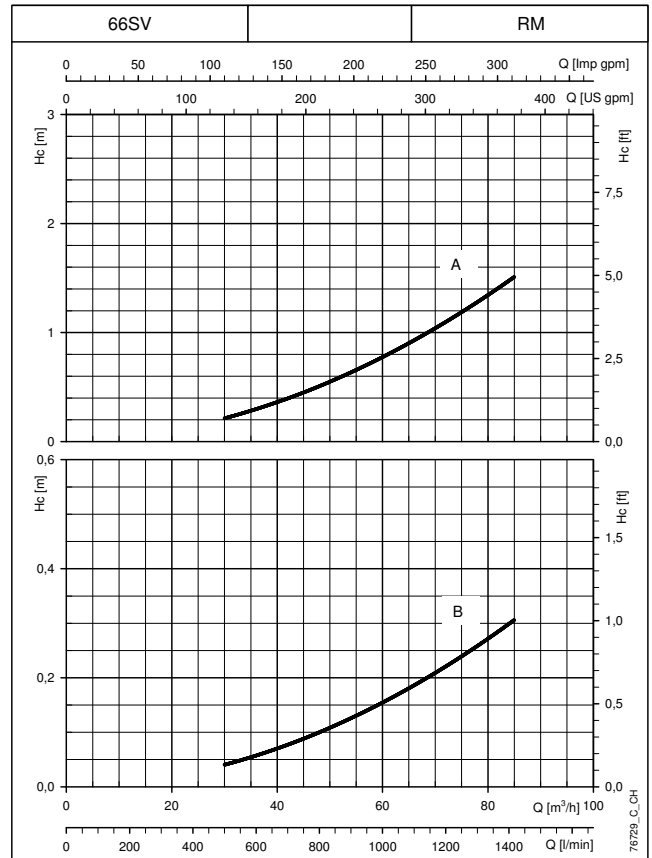
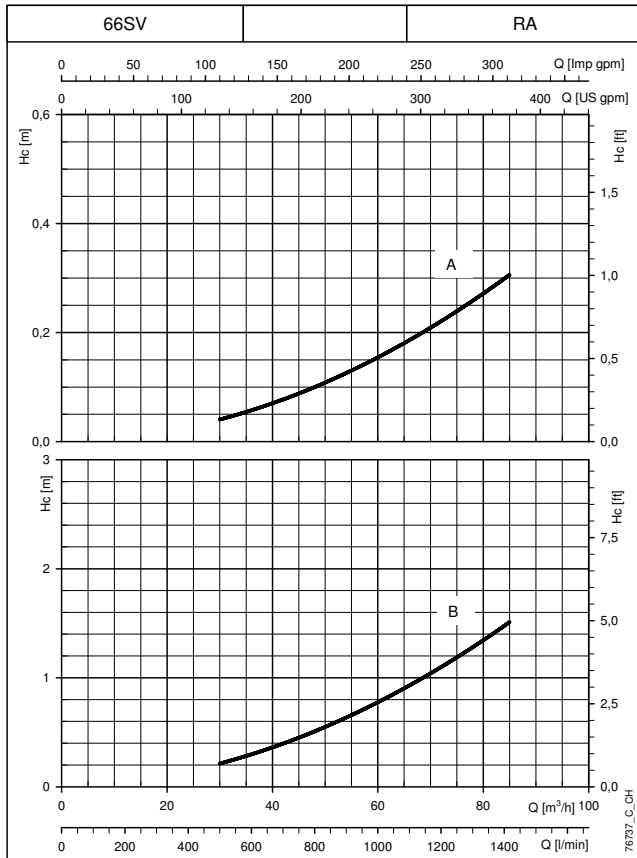

The declared curves are valid for liquids with density $\rho = 1 \text{ Kg/dm}^3$ and kinematic viscosity $\nu = 1 \text{ mm}^2/\text{sec}$.
H_c (A): Pressure drop curve on delivery side of the pump. H_c (B): Pressure drop curve on suction side of the pump.
RA: check valve on suction side. RM: check valve on delivery side.
The pressure drops do not consider the distributed pressure drops on the manifold.

CURVE

BOOSTER SETS, GVF.../SV SERIES
H_c PRESSURE DROP CURVE

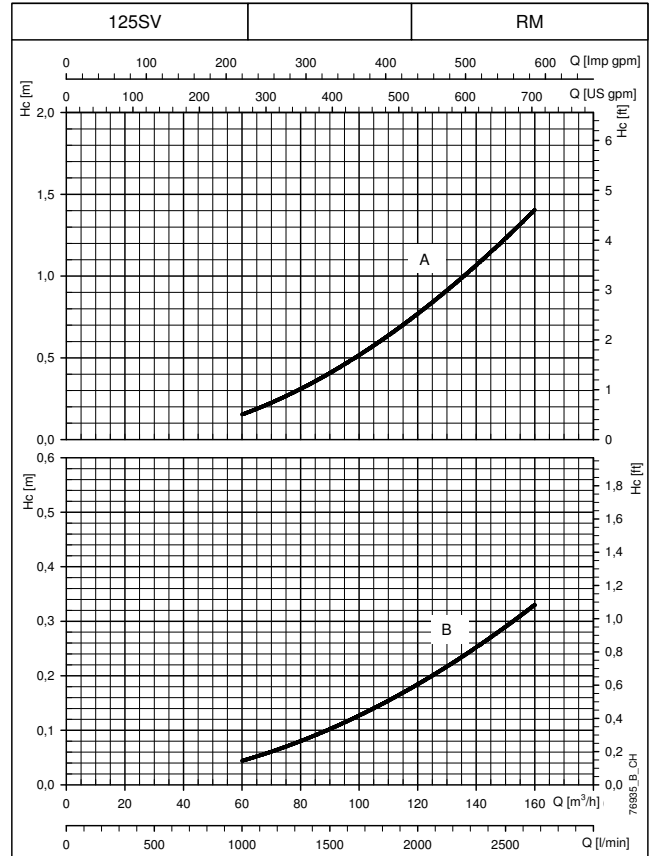
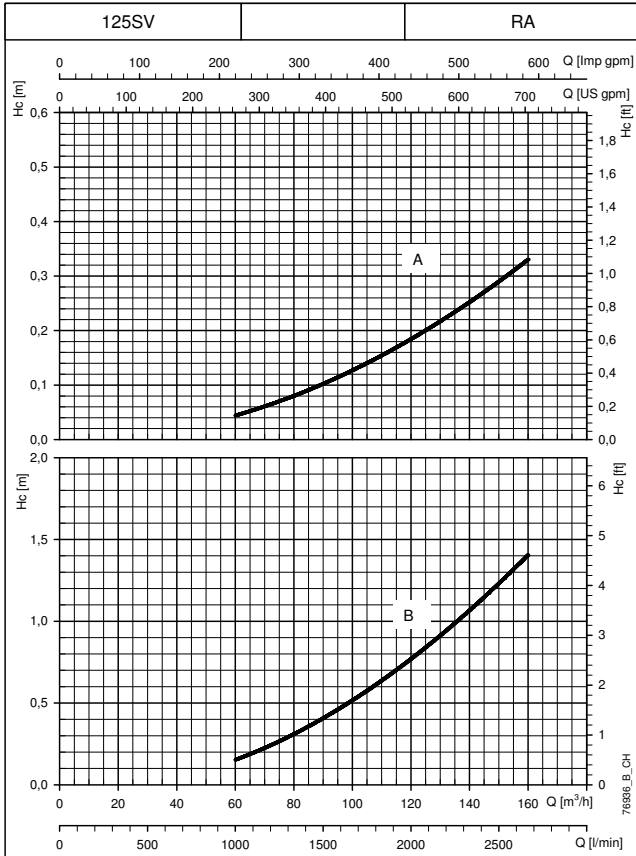

The declared curves are valid for liquids with density $\rho = 1 \text{ Kg/dm}^3$ and kinematic viscosity $\nu = 1 \text{ mm}^2/\text{sec}$.
H_c (A): Pressure drop curve on delivery side of the pump. H_c (B): Pressure drop curve on suction side of the pump.
RA: check valve on suction side. RM: check valve on delivery side.
The pressure drops do not consider the distributed pressure drops on the manifold.

ACCESSORIES

EXPANSION VESSELS

Booster sets have delivery manifolds with attachments for the installation of 8 or 24 litre diaphragm expansion vessels (hydrotube).

The caps for sealing any unused attachments are supplied with the set.

Any large size vessels can be connected to the unused end of the delivery manifold.

For proper sizing of the vessel, please refer to the technical appendix.

Kits featuring the following accessories are **available on request**:

- expansion vessel.
- on-off valve.
- instructions sheet.
- packing.

DIAPHRAGM EXPANSION VESSELS KITS

Volume Litres	PN bar	DIMENSIONS (mm)			Materials		
		ø A	B	Valve	Diaphragm	Vessel	Valve
8	8	205	390	1" FF	EPDM	Painted steel	Nickel-plated brass
24	8	270	555	1" FF	EPDM	Painted steel	Nickel-plated brass
24	10	270	555	1" FF	EPDM	Painted steel	Nickel-plated brass
24	16	270	555	1" FF	EPDM	Painted steel	Nickel-plated brass
24	10	270	575	1" FF	Butyl	Stainless steel	AISI 316 stainless steel
20	25	270	555	1" FF	EPDM	Painted steel	Nickel-plated brass

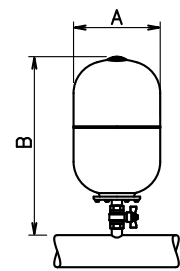

BETT-VAS1_A_DD

Gcom-vmb-en_c_td

FLANGE KIT

Manifolds are supplied with threaded attachments and caps for sealing the unused ends.

For these manifolds, stainless steel AISI 304 or 316 flanges for connection to the system are available on request.

THREADED COUNTERFLANGES

KIT TYPE	DN	ø C	DIMENSIONS (mm)				HOLES		
			ø A	B	ø D	H	ø F	N°	PN
2"	50	Rp 2	125	16	165	24	18	4	25
2" 1/2	65	Rp 2 1/2	145	16	185	23	18	4	16
3"	80	Rp 3	160	17	200	27	18	8	16

Gcom-cf-tonde-f-en_a_td

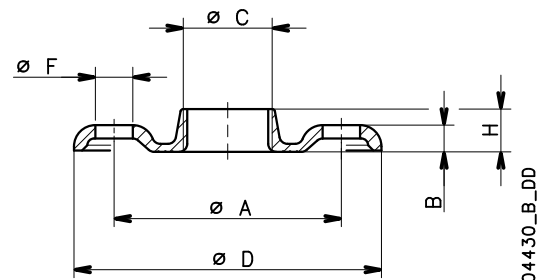

04430_B_DD

WELD-ON COUNTERFLANGES

KIT TYPE	DN	ø C	DIMENSIONS (mm)				HOLES		
			ø A	B	ø D	ø F	N°	PN	
2"	50	61	125	19	165	18	4	16	
2" 1/2	65	77	145	20	185	18	4	16	
3"	80	90	160	20	200	18	8	16	
4"	100	116	180	22	220	18	8	16	
5"	125	141,5	210	22	250	18	8	16	
6"	150	170,5	240	24	285	22	8	16	
8"	200	221,5	295	26	340	22	12	16	
10"	250	276,5	355	29	405	26	12	16	
12"	300	327,5	410	32	460	26	12	16	

Gcom-cf-tonde-s-en_c_td

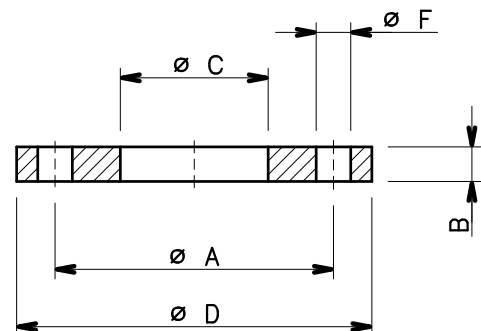

04431_A_DD

ANTI-VIBRATION JOINT KIT

Anti-vibration joints, or compensation joints, can be used to absorb deformations, expansions, pipe noise and reduce water hammering.

They can also withstand a high level of vacuum, which enables the absorption of negative expansions due to depression.

Due to its elasticity, the material can deform or expand as necessary, making installation easier, simpler and quicker, even when the piping is not aligned.

TABELLA 1 TABLE 1		A-B-C-D non possono essere sommati				A-B-C-D can not be cumulative
GIUNTI ELASTICI RUBBER EXPANSION JOINT		L	A	B	C	D
DN		mm	mm	mm	mm	(°)
32	1"1/4	95	8	4	8	15
40	1"1/2	95	8	4	8	15
50	2"	105	8	5	8	15
65	2"1/2	115	12	6	10	15
80	3"	130	12	6	10	15
100	4"	135	18	10	12	15
125	5"	170	18	10	12	15
150	6"	180	18	10	12	15
200	8"	205	25	14	22	15
250	10"	240	25	14	22	15
300	12"	260	25	14	22	15
350	14"	265	25	16	22	15
400	16"	265	25	16	22	15
450	18"	265	25	16	22	15
500	20"	265	25	16	22	15

GD_JOINT_A_TD

PROTECTION SYSTEMS AGAINST DRY RUNNING

To avoid damaging the pumps, protection systems must be used to prevent it from dry running.

FLOAT SWITCH PROTECTION

The float switch system is used for supplies from open tanks. The float switch immersed in the tank must be connected to the control panel.

If there is no water, the float switch opens the electrical contact and the electric pumps stop.

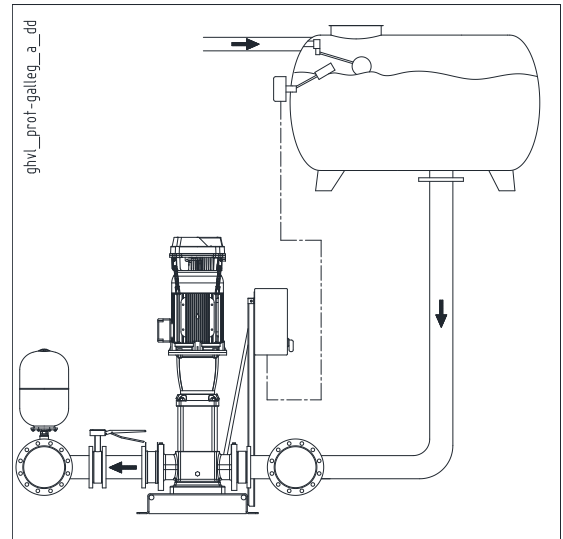

ELECTRODE PROBE PROTECTION

The system with electrode probes is used for supplies from open tanks or wells.

Three probes are directly connected to the electric module with adjustable sensitivity that can be installed in the control panel.

If there is no water, the control circuit opens the electrical contact and the electric pumps stop.

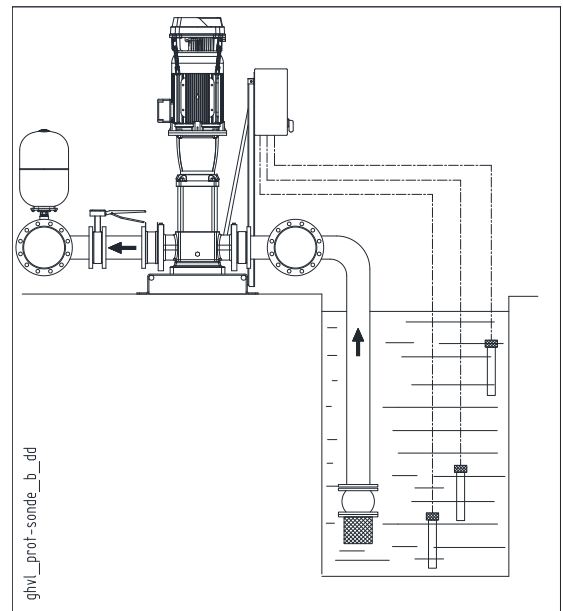

MINIMUM PRESSURE SWITCH PROTECTION

The system with minimum pressure switch is used for water supplies from pressurised networks or tanks. The pressure switch is connected to the control panel. In case of water shortage, it opens the electric contact, causing the stop of the electric pumps.

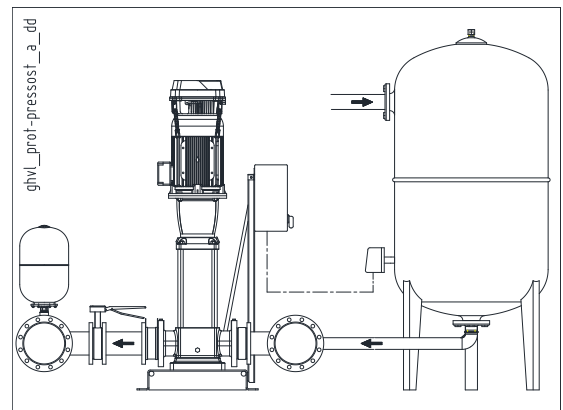

ELECTRONIC MODULE

Depending on the type and version of the installation (GVE, GVF, GVM, GVS) and on the total number of pumps, it is sometimes necessary to connect an additional external relay output module to the MASTER serial port of the SD60 unit. This module is necessary to control starting of the pumps if the relay outputs of the SD60 control unit are exhausted.

Key:

- A= Module of 5 relay outputs.
- J = Presence of jockey pump.
- R= Presence of standby pump.
- B= 10 digital inputs module pump run status.

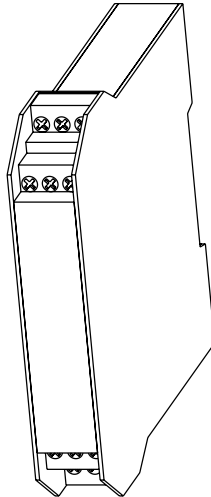

GV	Booster with only duty pumps				
	2P	3P	4P	5P	6P
E	-	-	-	-	-
F	-	-	A1+B	A1+B	A1+A2+B
M	-	-	-	-	-
S	-	-	-	-	-

GV	Booster with duty pumps and jockey (fixed speed)				
	J + 1P	J+ 2P	J+ 3P	J+ 4P	J+ 5P
E	-	-	-	-	-
F	A1+B	A1+B	A1+B	A1+B	A1+B
M	-	-	-	-	-
S	-	-	-	-	-

GV	Booster with duty pumps, jockey (fixed or variable speed) and pump reserve				
	J + R + 1P	J + R+ 2P	J + R+ 3P	J + R+ 4P	
E	-	-	-	-	-
F	A1+B	A1+B	A1+B	A1+B	-
M	-	-	-	-	-
S	-	-	-	-	-

GV	Booster with duty pumps and pump reserve				
	R + 1P	R+ 2P	R+ 3P	R+ 4P	R+ 5P
E	-	-	-	-	-
F	-	-	A1+B	A1+B	A1+B
M	-	-	-	-	-
S	-	-	-	-	-

GV_mod_agg-en-c_td

TECHNICAL APPENDIX

TECHNICAL APPENDIX VAPOUR PRESSURE PS VAPOUR PRESSURE AND ρ DENSITY OF WATER TABLE

t °C	T K	ps bar	ρ kg/dm ³	t °C	T K	ps bar	ρ kg/dm ³	t °C	T K	ps bar	ρ kg/dm ³
0	273,15	0,00611	0,9998	55	328,15	0,15741	0,9857	120	393,15	1,9854	0,9429
1	274,15	0,00657	0,9999	56	329,15	0,16511	0,9852	122	395,15	2,1145	0,9412
2	275,15	0,00706	0,9999	57	330,15	0,17313	0,9846	124	397,15	2,2504	0,9396
3	276,15	0,00758	0,9999	58	331,15	0,18147	0,9842	126	399,15	2,3933	0,9379
4	277,15	0,00813	1,0000	59	332,15	0,19016	0,9837	128	401,15	2,5435	0,9362
5	278,15	0,00872	1,0000	60	333,15	0,1992	0,9832	130	403,15	2,7013	0,9346
6	279,15	0,00935	1,0000	61	334,15	0,2086	0,9826	132	405,15	2,867	0,9328
7	280,15	0,01001	0,9999	62	335,15	0,2184	0,9821	134	407,15	3,041	0,9311
8	281,15	0,01072	0,9999	63	336,15	0,2286	0,9816	136	409,15	3,223	0,9294
9	282,15	0,01147	0,9998	64	337,15	0,2391	0,9811	138	411,15	3,414	0,9276
10	283,15	0,01227	0,9997	65	338,15	0,2501	0,9805	140	413,15	3,614	0,9258
11	284,15	0,01312	0,9997	66	339,15	0,2615	0,9799	145	418,15	4,155	0,9214
12	285,15	0,01401	0,9996	67	340,15	0,2733	0,9793	155	428,15	5,433	0,9121
13	286,15	0,01497	0,9994	68	341,15	0,2856	0,9788	160	433,15	6,181	0,9073
14	287,15	0,01597	0,9993	69	342,15	0,2984	0,9782	165	438,15	7,008	0,9024
15	288,15	0,01704	0,9992	70	343,15	0,3116	0,9777	170	433,15	7,920	0,8973
16	289,15	0,01817	0,9990	71	344,15	0,3253	0,9770	175	448,15	8,924	0,8921
17	290,15	0,01936	0,9988	72	345,15	0,3396	0,9765	180	453,15	10,027	0,8869
18	291,15	0,02062	0,9987	73	346,15	0,3543	0,9760	185	458,15	11,233	0,8815
19	292,15	0,02196	0,9985	74	347,15	0,3696	0,9753	190	463,15	12,551	0,8760
20	293,15	0,02337	0,9983	75	348,15	0,3855	0,9748	195	468,15	13,987	0,8704
21	294,15	0,24850	0,9981	76	349,15	0,4019	0,9741	200	473,15	15,550	0,8647
22	295,15	0,02642	0,9978	77	350,15	0,4189	0,9735	205	478,15	17,243	0,8588
23	296,15	0,02808	0,9976	78	351,15	0,4365	0,9729	210	483,15	19,077	0,8528
24	297,15	0,02982	0,9974	79	352,15	0,4547	0,9723	215	488,15	21,060	0,8467
25	298,15	0,03166	0,9971	80	353,15	0,4736	0,9716	220	493,15	23,198	0,8403
26	299,15	0,03360	0,9968	81	354,15	0,4931	0,9710	225	498,15	25,501	0,8339
27	300,15	0,03564	0,9966	82	355,15	0,5133	0,9704	230	503,15	27,976	0,8273
28	301,15	0,03778	0,9963	83	356,15	0,5342	0,9697	235	508,15	30,632	0,8205
29	302,15	0,04004	0,9960	84	357,15	0,5557	0,9691	240	513,15	33,478	0,8136
30	303,15	0,04241	0,9957	85	358,15	0,5780	0,9684	245	518,15	36,523	0,8065
31	304,15	0,04491	0,9954	86	359,15	0,6011	0,9678	250	523,15	39,776	0,7992
32	305,15	0,04753	0,9951	87	360,15	0,6249	0,9671	255	528,15	43,246	0,7916
33	306,15	0,05029	0,9947	88	361,15	0,6495	0,9665	260	533,15	46,943	0,7839
34	307,15	0,05318	0,9944	89	362,15	0,6749	0,9658	265	538,15	50,877	0,7759
35	308,15	0,05622	0,9940	90	363,15	0,7011	0,9652	270	543,15	55,058	0,7678
36	309,15	0,05940	0,9937	91	364,15	0,7281	0,9644	275	548,15	59,496	0,7593
37	310,15	0,06274	0,9933	92	365,15	0,7561	0,9638	280	553,15	64,202	0,7505
38	311,15	0,06624	0,9930	93	366,15	0,7849	0,9630	285	558,15	69,186	0,7415
39	312,15	0,06991	0,9927	94	367,15	0,8146	0,9624	290	563,15	74,461	0,7321
40	313,15	0,07375	0,9923	95	368,15	0,8453	0,9616	295	568,15	80,037	0,7223
41	314,15	0,07777	0,9919	96	369,15	0,8769	0,9610	300	573,15	85,927	0,7122
42	315,15	0,08198	0,9915	97	370,15	0,9094	0,9602	305	578,15	92,144	0,7017
43	316,15	0,09639	0,9911	98	371,15	0,9430	0,9596	310	583,15	98,70	0,6906
44	317,15	0,09100	0,9907	99	372,15	0,9776	0,9586	315	588,15	105,61	0,6791
45	318,15	0,09582	0,9902	100	373,15	1,0133	0,9581	320	593,15	112,89	0,6669
46	319,15	0,10086	0,9898	102	375,15	1,0878	0,9567	325	598,15	120,56	0,6541
47	320,15	0,10612	0,9894	104	377,15	1,1668	0,9552	330	603,15	128,63	0,6404
48	321,15	0,11162	0,9889	106	379,15	1,2504	0,9537	340	613,15	146,05	0,6102
49	322,15	0,11736	0,9884	108	381,15	1,3390	0,9522	350	623,15	165,35	0,5743
50	323,15	0,12335	0,9880	110	383,15	1,4327	0,9507	360	633,15	186,75	0,5275
51	324,15	0,12961	0,9876	112	385,15	1,5316	0,9491	370	643,15	210,54	0,4518
52	325,15	0,13613	0,9871	114	387,15	1,6362	0,9476	374,15	647,30	221,20	0,3154
53	326,15	0,14293	0,9862	116	389,15	1,7465	0,9460				
54	327,15	0,15002	0,9862	118	391,15	1,8628	0,9445				

G-at_npsh_a_sc

PERFORMANCE WITH VARYING SPEED EQUIVALENCE RELATIONS

Fitting the electric pump with a frequency converter makes it possible to vary the pump rotation speed, normally according to the system pressure parameter.

Variations in electric pump speed result in **modified performances** according to the equivalence relations.

Flow rate	$\frac{Q1}{Q2} = \left[\frac{n1}{n2} \right]$
Head	$\frac{H1}{H2} = \left[\frac{n1}{n2} \right]^2$
Power	$\frac{P1}{P2} = \left[\frac{n1}{n2} \right]^3$

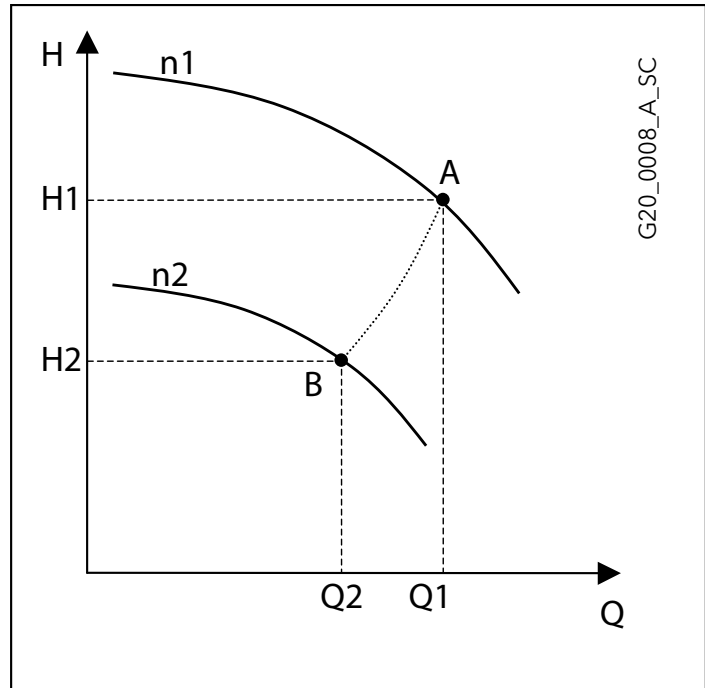

n1 = initial speed;
Q1= initial flow rate;
H1 = initial head;
P1 = initial power;

n2= speed required.
Q2= flow rate required.
H2= head required.
P2= power required

Frequency ratios can be used instead of speed in practical applications, keeping 30 Hz as the bottom limit.

Example : 2-pole 50 Hz electric pump n1 =2900 (point A)

Flow rate (A) = 100 l/min; Head (A) = 50m

By reducing the frequency to 30 Hz the speed is reduced to approx. n2 = 1740 rpm (point B)

Flow rate (B) = 60 l/min; Head (B) = 18 m

The power of the new work point B is cut to about 22% of the initial power.

SIZING THE DIAPHRAGM TANK IN SYSTEMS WITH SPEED VARIATION

Variable speed booster sets need **smaller tanks** compared to traditional systems. Generally speaking, a tank with a litre capacity of just 10% of the nominal capacity of a single pump, expressed in litres per minute, is needed.

The **gradual starting** of the pumps controlled by the frequency converters reduces the need to limit the number of hourly starts; the main purpose of the tank is to compensate for small system losses, stabilize the pressure and make up for pressure variations caused by sudden demand.

Make the following calculation:

Set made up of three electric pumps, each with a maximum flow rate of 400 l/min, for a total capacity of 1200 l/min. The **volume** required for the tank is 40 litres. This size can be obtained by using two 24-litre tanks mounted directly onto the set's manifold.

The calculation establishes the minimum value needed for proper operation.

TABLE OF FLOW RESISTANCE IN 100 m OF STRAIGHT CAST IRON PIPELINE (HAZEN-WILLIAMS FORMULA C=100)

FLOW RATE		NOMINAL DIAMETER in mm and INCHES																		
m ³ /h	l/min		15	20	25	32	40	50	65	80	100	125	150	175	200	250	300	350	400	
			1/2"	3/4"	1"	1 1/4"	1 1/2"	2	2 1/2"	3"	4"	5"	6"	7"	8"	10"	12"	14"	16"	
0,6	10	v	0,94	0,53	0,34	0,21	0,13													
		hr	16	3,94	1,33	0,40	0,13													
0,9	15	v	1,42	0,80	0,51	0,31	0,20													
		hr	33,9	8,35	2,82	0,85	0,29													
1,2	20	v	1,89	1,06	0,68	0,41	0,27	0,17												
		hr	57,7	14,21	4,79	1,44	0,49	0,16												
1,5	25	v	2,36	1,33	0,85	0,52	0,33	0,21												
		hr	87,2	21,5	7,24	2,18	0,73	0,25												
1,8	30	v	2,83	1,59	1,02	0,62	0,40	0,25												
		hr	122	30,1	10,1	3,05	1,03	0,35												
2,1	35	v	3,30	1,86	1,19	0,73	0,46	0,30												
		hr	162	40,0	13,5	4,06	1,37	0,46												
2,4	40	v		2,12	1,36	0,83	0,53	0,34	0,20											
		hr		51,2	17,3	5,19	1,75	0,59	0,16											
3	50	v		2,65	1,70	1,04	0,66	0,42	0,25											
		hr		77,4	26,1	7,85	2,65	0,89	0,25											
3,6	60	v		3,18	2,04	1,24	0,80	0,51	0,30											
		hr		108	36,6	11,0	3,71	1,25	0,35											
4,2	70	v		3,72	2,38	1,45	0,93	0,59	0,35											
		hr		144	48,7	14,6	4,93	1,66	0,46											
4,8	80	v		4,25	2,72	1,66	1,06	0,68	0,40											
		hr		185	62,3	18,7	6,32	2,13	0,59											
5,4	90	v			3,06	1,87	1,19	0,76	0,45	0,30										
		hr			77,5	23,3	7,85	2,65	0,74	0,27										
6	100	v			3,40	2,07	1,33	0,85	0,50	0,33										
		hr			94,1	28,3	9,54	3,22	0,90	0,33										
7,5	125	v			4,25	2,59	1,66	1,06	0,63	0,41										
		hr			142	42,8	14,4	4,86	1,36	0,49										
9	150	v				3,11	1,99	1,27	0,75	0,50	0,32									
		hr				59,9	20,2	6,82	1,90	0,69	0,23									
10,5	175	v				3,63	2,32	1,49	0,88	0,58	0,37									
		hr				79,7	26,9	9,07	2,53	0,92	0,31									
12	200	v				4,15	2,65	1,70	1,01	0,66	0,42									
		hr				102	34,4	11,6	3,23	1,18	0,40									
15	250	v				5,18	3,32	2,12	1,26	0,83	0,53	0,34								
		hr				154	52,0	17,5	4,89	1,78	0,60	0,20								
18	300	v				3,98	2,55	1,51	1,00	0,64	0,41									
		hr				72,8	24,6	6,85	2,49	0,84	0,28									
24	400	v					5,31	3,40	2,01	1,33	0,85	0,54	0,38							
		hr					124	41,8	11,66	4,24	1,43	0,48	0,20							
30	500	v					6,63	4,25	2,51	1,66	1,06	0,68	0,47							
		hr					187	63,2	17,6	6,41	2,16	0,73	0,30							
36	600	v					5,10	3,02	1,99	1,27	0,82	0,57	0,42							
		hr					88,6	24,7	8,98	3,03	1,02	0,42	0,20							
42	700	v					5,94	3,52	2,32	1,49	0,95	0,66	0,49							
		hr					118	32,8	11,9	4,03	1,36	0,56	0,26							
48	800	v					6,79	4,02	2,65	1,70	1,09	0,75	0,55							
		hr					151	42,0	15,3	5,16	1,74	0,72	0,34							
54	900	v					7,64	4,52	2,99	1,91	1,22	0,85	0,62							
		hr					188	52,3	19,0	6,41	2,16	0,89	0,42							
60	1000	v						5,03	3,32	2,12	1,36	0,94	0,69	0,53						
		hr						63,5	23,1	7,79	2,63	1,08	0,51	0,27						
75	1250	v						6,28	4,15	2,65	1,70	1,18	0,87	0,66						
		hr						96,0	34,9	11,8	3,97	1,63	0,77	0,40						
90	1500	v						7,54	4,98	3,18	2,04	1,42	1,04	0,80						
		hr						134	48,9	16,5	5,57	2,29	1,08	0,56						
105	1750	v						8,79	5,81	3,72	2,38	1,65	1,21	0,93						
		hr						179	65,1	21,9	7,40	3,05	1,44	0,75						
120	2000	v							6,63	4,25	2,72	1,89	1,39	1,06	0,68					
		hr							83,3	28,1	9,48	3,90	1,84	0,96	0,32					
150	2500	v							8,29	5,31	3,40	2,36	1,73	1,33	0,85					
		hr							126	42,5	14,3	5,89	2,78	1,45	0,49					
180	3000	v								6,37	4,08	2,83	2,08	1,59	1,02	0,71				
		hr								59,5	20,1	8,26	3,90	2,03	0,69	0,28				
210	3500	v								7,43	4,76	3,30	2,43	1,86	1,19	0,83				
		hr								79,1	26,7	11,0	5,18	2,71	0,91	0,38				
240	4000	v								8,49	5,44	3,77	2,77	2,12	1,36	0,94				
		hr								101	34,2	14,1	6,64	3,46	1,17	0,48				
300	5000	v									6,79	4,72	3,47	2,65	1,70	1,18				
		hr									51,6	21,2	10,0	5,23	1,77	0,73				
360	6000	v									8,15	5,66	4,16	3,18	2,04	1,42				
		hr									72,3	29,8	14,1	7,33	2,47	1,02				
420	7000	v										6,61	4,85	3,72	2,38	1,65	1,21			
		hr										39,6	18,7	9,75	3,29	1,35	0,64			
480	8000	v											7,55	5,55	4,25	2,72	1,89	1,39		
		hr											50,7	23,9	12,49	4,21	1,73	0,82		
540	9000	v												8,49	6,24	4,78	3,06	2,12	1,56	1,19
		hr												63,0	29,8	15,5	5,24	2,16	1,02	0,53
600	10000	v													6,93	5,31	3,40	2,36	1,73	1,33

FLOW RESISTANCE

TABLE OF FLOW RESISTANCE IN BENDS, VALVES AND GATES

The flow resistance is calculated using the equivalent pipeline length method according to the table below:

ACCESSORY TYPE	DN											
	25	32	40	50	65	80	100	125	150	200	250	300
	Equivalent pipeline length (m)											
45° bend	0,2	0,2	0,4	0,4	0,6	0,6	0,9	1,1	1,5	1,9	2,4	2,8
90° bend	0,4	0,6	0,9	1,1	1,3	1,5	2,1	2,6	3,0	3,9	4,7	5,8
90° smooth bend	0,4	0,4	0,4	0,6	0,9	1,1	1,3	1,7	1,9	2,8	3,4	3,9
Union tee or cross	1,1	1,3	1,7	2,1	2,6	3,2	4,3	5,3	6,4	7,5	10,7	12,8
Gate	-	-	-	0,2	0,2	0,2	0,4	0,4	0,6	0,9	1,1	1,3
Non return valve	1,1	1,5	1,9	2,4	3,0	3,4	4,7	5,9	7,4	9,6	11,8	13,9

G-a-pcv_a_th

The table is valid for the Hazen Williams coefficient $C = 100$ (cast iron pipework). For steel pipework, multiply the values by 1.41. For stainless steel, copper and coated cast iron pipework, multiply the values by 1.85. When the **equivalent pipeline length** has been determined, the flow resistance is obtained from the table of flow resistance.

The values given are guideline values which are bound to vary slightly according to the model, especially for gate valves and non-return valves, for which it is a good idea to check the values supplied by the manufacturers.

VOLUMETRIC CAPACITY

Litres per minute l/min	Cubic metres per hour m ³ /h	Cubic feet per hour ft ³ /h	Cubic feet per minute ft ³ /min	Imperial gallon per minute Imp. gal/min	U.S. gallon per minute US gal/min
1,000	0,0600	2,1189	0,0353	0,2200	0,2642
16,6667	1,0000	35,3147	0,5886	3,6662	4,4029
0,4719	0,0283	1,0000	0,0167	0,1038	0,1247
28,3168	1,6990	60,0000	1,0000	6,2288	7,4805
4,5461	0,2728	9,6326	0,1605	1,0000	1,2009
3,7854	0,2271	8,0208	0,1337	0,8327	1,0000

PRESSURE AND HEAD

Newton per square metre N/m ²	kilo Pascal kPa	bar bar	Pound force per square inch psi	Metre of water m H ₂ O	Millimetre of mercury mm Hg
1,0000	0,0010	1 x 10 ⁻⁵	1,45 x 10 ⁻⁴	1,02 x 10 ⁻⁴	0,0075
1 000,0000	1,0000	0,0100	0,1450	0,1020	7,5006
1 x 10 ⁵	100,0000	1,0000	14,5038	10,1972	750,0638
6 894,7570	6,8948	0,0689	1,0000	0,7031	51,7151
9 806,6500	9,8067	0,0981	1,4223	1,0000	73,5561
133,3220	0,1333	0,0013	0,0193	0,0136	1,0000

LENGTH

Millimetre mm	Centimetre cm	Metre m	Inch in	Foot ft	Yard yd
1,0000	0,1000	0,0010	0,0394	0,0033	0,0011
10,0000	1,0000	0,0100	0,3937	0,0328	0,0109
1 000,0000	100,0000	1,0000	39,3701	3,2808	1,0936
25,4000	2,5400	0,0254	1,0000	0,0833	0,0278
304,8000	30,4800	0,3048	12,0000	1,0000	0,3333
914,4000	91,4400	0,9144	36,0000	3,0000	1,0000

VOLUME

Cubic metre m ³	Litre L	Millilitre ml	Imperial gallon imp. gal.	U.S. gallon US gal.	Cubic foot ft ³
1,0000	1 000,0000	1 x 10 ⁶	219,9694	264,1720	35,3147
0,0010	1,0000	1 000,0000	0,2200	0,2642	0,0353
1 x 10 ⁻⁶	0,0010	1,0000	2,2 x 10 ⁻⁴	2,642 x 10 ⁻⁴	3,53 x 10 ⁻⁵
0,0045	4,5461	4 546,0870	1,0000	1,2009	0,1605
0,0038	3,7854	3 785,4120	0,8327	1,0000	0,1337
0,0283	28,3168	28 316,8466	6,2288	7,4805	1,0000

TEMPERATURE

Water	Kelvin K	Celsius °C	Fahrenheit °F	$^{\circ}\text{F} = ^{\circ}\text{C} \times \frac{9}{5} + 32$ $^{\circ}\text{C} = (^{\circ}\text{F} - 32) \times \frac{5}{9}$
icing	273,1500	0,0000	32,0000	
boiling	373,1500	100,0000	212,0000	

G-at_pp-en_b_sc

FURTHER PRODUCT SELECTION AND DOCUMENTATION

Xylect™

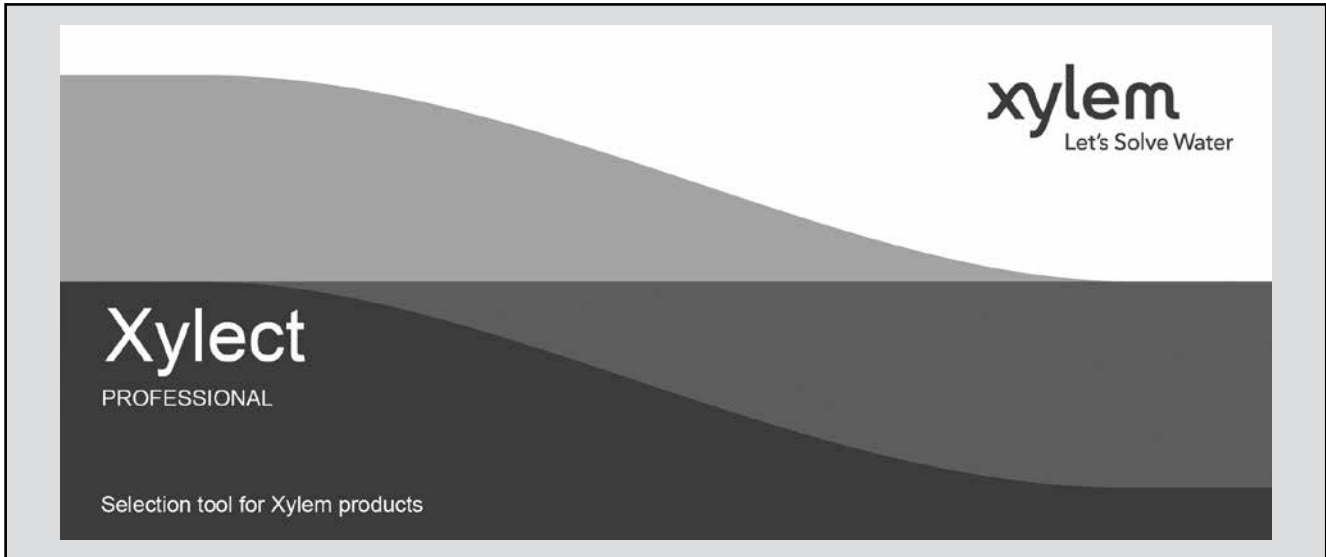

Xylect™ is pump solution selection software with an extensive online database of product information across the entire range of pumps and related products, with multiple search options and helpful project management facilities. The system holds up-to-date product information on thousands of products and accessories.

The possibility to search by applications and the detailed information output given makes it easy to make the optimal selection without having detailed knowledge about the products.

The search can be made by:

- Application
- Product type
- Duty point

Xylect™ gives a detailed output:

- List with search results
- Performance curves (flow, head, power, efficiency, NPSH)
- Motor data
- Dimensional drawings
- Options
- Data sheet printouts
- Document downloads incl dxf files

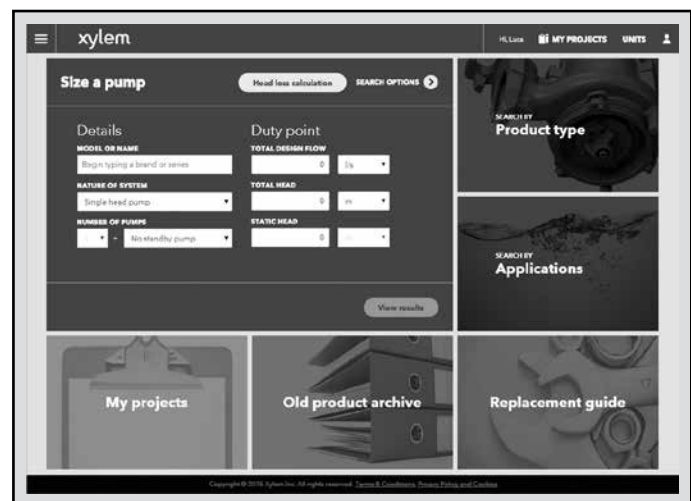

The search by application guides users not familiar with the product range to the right choice.

FURTHER PRODUCT SELECTION AND DOCUMENTATION

Xylect™



The detailed output makes it easy to select the optimal pump from the given alternatives.

The best way to work with Xylect™ is to create a personal account. This makes it possible to:

- Set own standard units
- Create and save projects
- Share projects with other Xylect™ users

Every registered user has a proper space, where all projects are saved.

For more information about Xylect™ please contact our sales network or visit www.xylect.com.

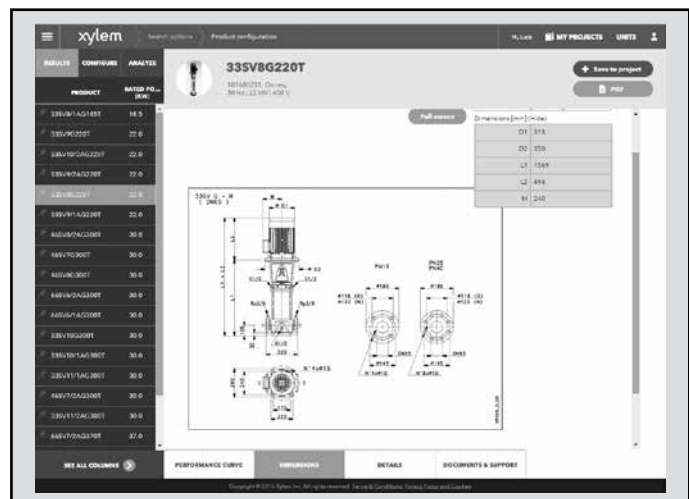

Dimensional drawings appear on the screen and can be downloaded in dxf format.

Xylem |'zīləm|



- 1) The tissue in plants that brings water upward from the roots;
- 2) a leading global water technology company.

We're a global team unified in a common purpose: creating advanced technology solutions to the world's water challenges. Developing new technologies that will improve the way water is used, conserved, and re-used in the future is central to our work. Our products and services move, treat, analyze, monitor and return water to the environment, in public utility, industrial, residential and commercial building services, and agricultural settings. With its October 2016 acquisition of Sensus, Xylem added smart metering, network technologies and advanced data analytics for water, gas and electric utilities to its portfolio of solutions. In more than 150 countries, we have strong, long-standing relationships with customers who know us for our powerful combination of leading product brands and applications expertise with a strong focus on developing comprehensive, sustainable solutions.

For more information on how Xylem can help you, go to www.xylem.com.



For information and technical support
Xylem Service Italia Srl

Via Dottor Vittorio Lombardi 14
36075 - Montecchio Maggiore (VI) - Italy
Tel. (+39) 0444 707111
Fax (+39) 0444 491043
www.lowara.com

Xylem Service Italia Srl reserves the right to make modification without prior notice.
Lowara, Xylem are trademarks of Xylem Inc. or one of its subsidiaries
© 2017 Xylem, Inc.